

CATALOGUE S.P.A.N
MODELISME au 1/160^{ème}
EN IMPRESSION 3D

mars 2024 - V28

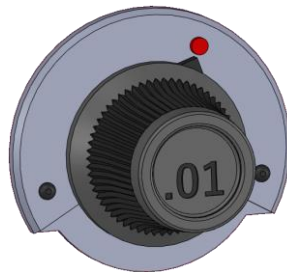



SOMMAIRE

MATERIEL ROULANT	4
X2400	5
X5600 + REMORQUE	6
X5500	7
X5800	8
X4200	9
X3700	10
VH Renault.....	11
VH AL Renault.....	12
ADN Standard-Nord	13
Remorque ADN – XR4000 court / long	14
DeDietrich 210cv.....	15
DeDietrich 270cv « gazo »	16
DeDietrich 500cv.....	17
CC40100	18
CC65000	19
CC72000	20
ADX.....	21
ABV (rame 2 éléments)	22
ABJ	23
AEK2.....	24
BUGATTI Présidentiel	25
BUGATTI double WR (2 éléments)	26
BUGATTI Triple (3 éléments).....	27
Rame Z5100 (3 éléments)	28
Rame TAR34 (3 éléments)	29
Rame ETG (4 éléments)	30
Rame « Saucisson » (2 éléments).....	31
Rame « MISTRAL » (3 éléments)	32
Rame « X72500 » (3 éléments)	33
Rame « X76500 » (3 éléments)	34
Rame RRR Carel –Fouché (3 éléments).....	35
Autorail « Pauline ».....	36
Autorail Renault ZO.....	37
Autorail FOUGA-DUNLOP	38
Voiture pilote Corail	39
Voiture pilote TER 200.....	40
Micheline type 15 – Est	41



Micheline type 17	42
Micheline type 23	43
DE DION BOUTON - OC1	44
DE DION BOUTON – OR	45
Autorail BILLARD A75D.....	46
Autorail BILLARD A150D.....	47
BB 1-80 (Biquette).....	48
BB 400	49
BB 8500	50
BB 9003	51
BB 12000	52
BB 16500	53
BB 36000	54
BB 66000	55
BB 67000	56
A1A A1A 62000	57
A1A A1A 68000	58
BB 75000	59
2D2.....	60
2D2 – nez de cochon	61
2D2 – WATERMAN	62
Picasso + remorque.....	63
Locotracteur YMO2100	64
Locotracteur BDR020	65
Fourgon « Orient Express ».....	66
Wagon B6Q.....	67
Wagon DD2.....	68
Wagon OCEM à rivets apparents	69
Remorque Verney – XR9500	70
Remorque Somua	70
ELEMENTS DE DECORS	71
Gares et bâtiments ferroviaires	72
GARES DU P.O.....	73
GARES « ETAT », « Charentes », Ouest.....	81
Maisons et commerces.....	101
Décors et accessoires	111
Véhicules (non roulants).....	131



Modélisme au 160^{ème} en impression 3D

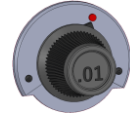

MATERIEL ROULANT

S.P.A.O.

12 rue Alain-fournier

53000 Laval

0619443310 - stpoup1@gmail.com

N°Siret : 891 865 883 00013



X2400

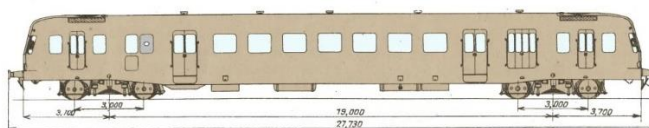
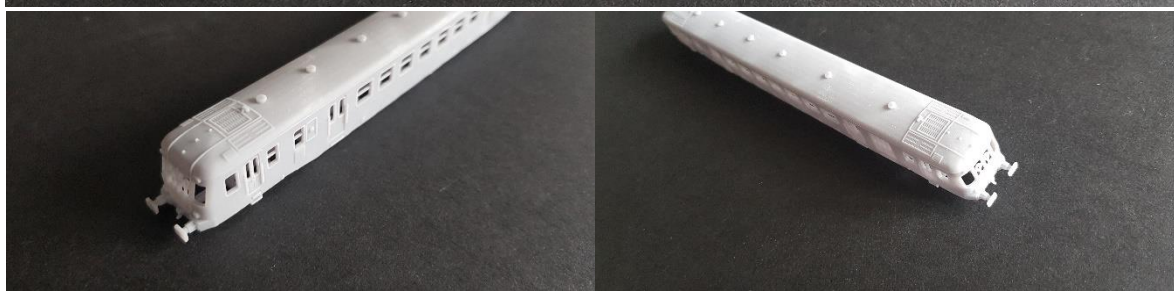

40€

S.P.A.N

12 rue Alain-fournier

53000 Laval

0619443310 - stpoup1@gmail.com

N°Siret : 891 865 883 00013



X5600 + REMORQUE

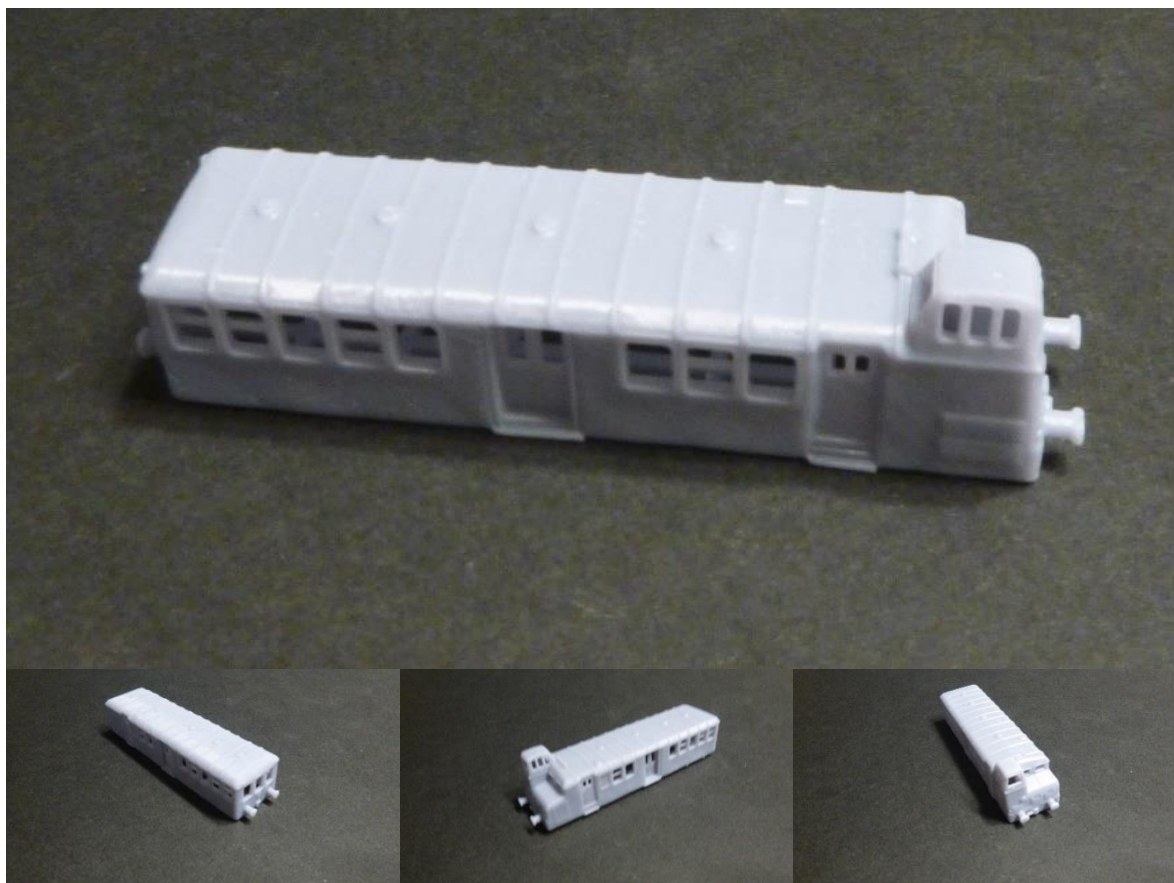

Existe en modèle diorama, livré avec banquettes (possibilité de vendre séparément la remorque et le X5600 (25€ / pièce).

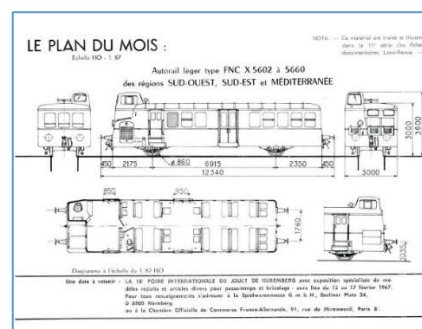

40€

S.P.A.N

12 rue Alain-fourmier

53000 Laval

0619443310 - stpoup1@gmail.com

N°Siret : 891 865 883 00013



X5500

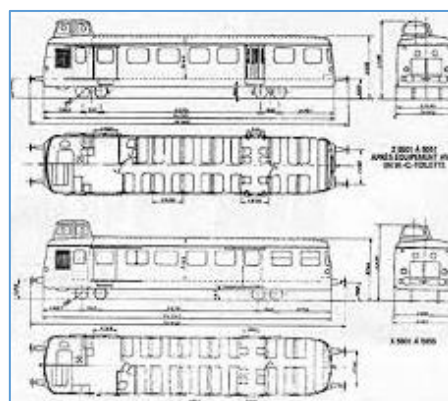

25 €

S.P.A.N

12 rue Alain-fourmier

53000 Laval

0619443310 - stpoup1@gmail.com

N°Siret : 891 865 883 00013



X5800



Remarque : Par rapport au X5500, les portes arrières sont coulissantes.

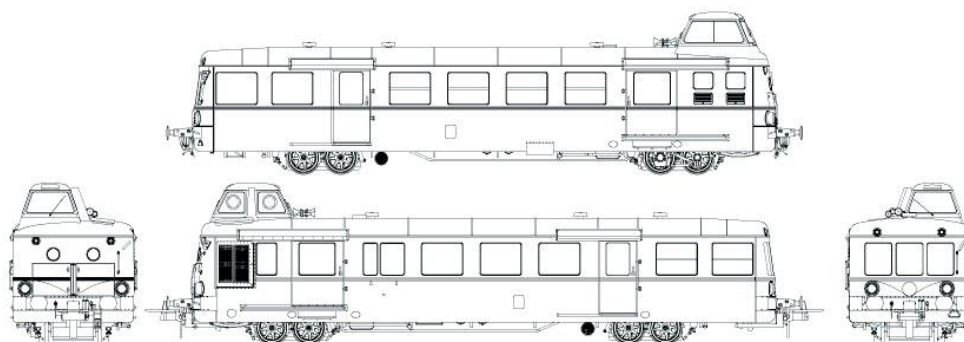

25 €

S.P.A.N

12 rue Alain-fournier

53000 Laval

0619443310 - stpoup1@gmail.com

N°Siret : 891 865 883 00013

X4200

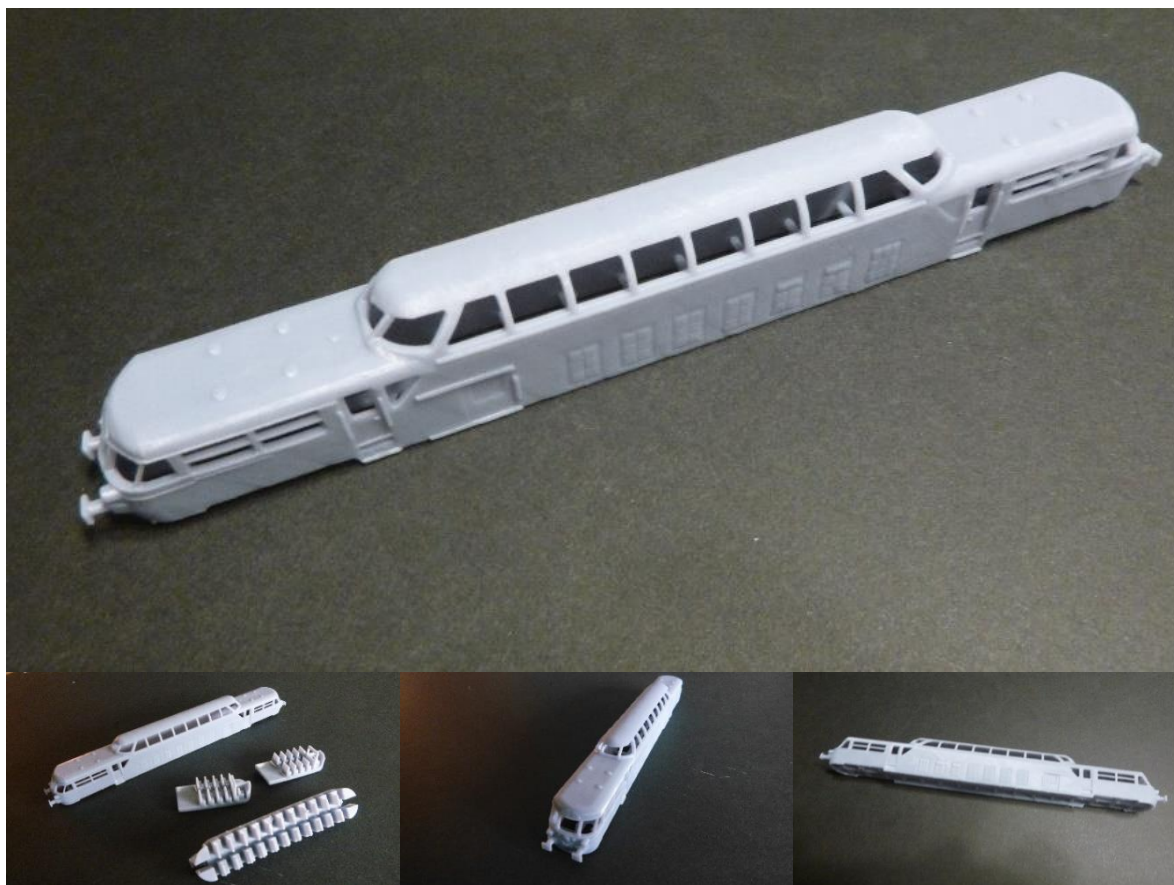

Le X4200 est livré avec ses banquettes, il existe en modèle diorama.

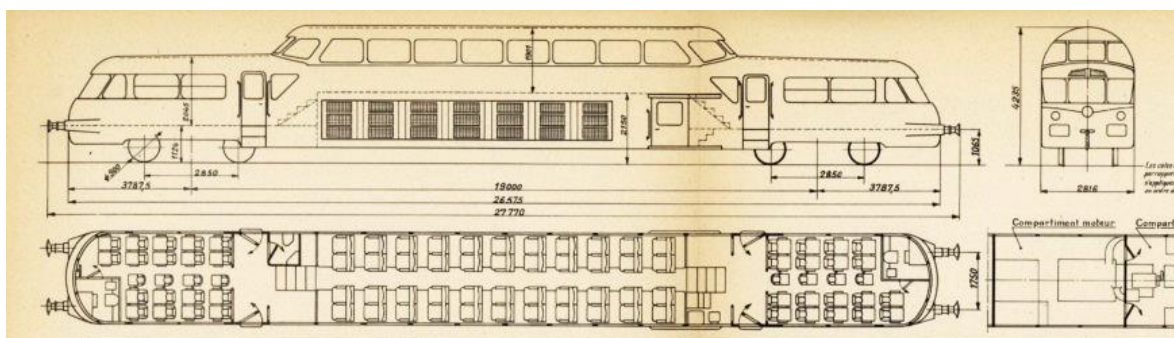

32 €

S.P.A.N

12 rue Alain-fournier

53000 Laval

0619443310 - stpoup1@gmail.com

N°Siret : 891 865 883 00013



X3700

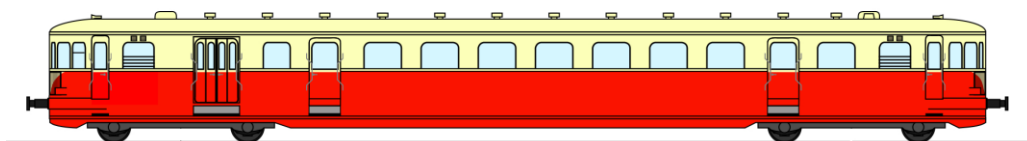
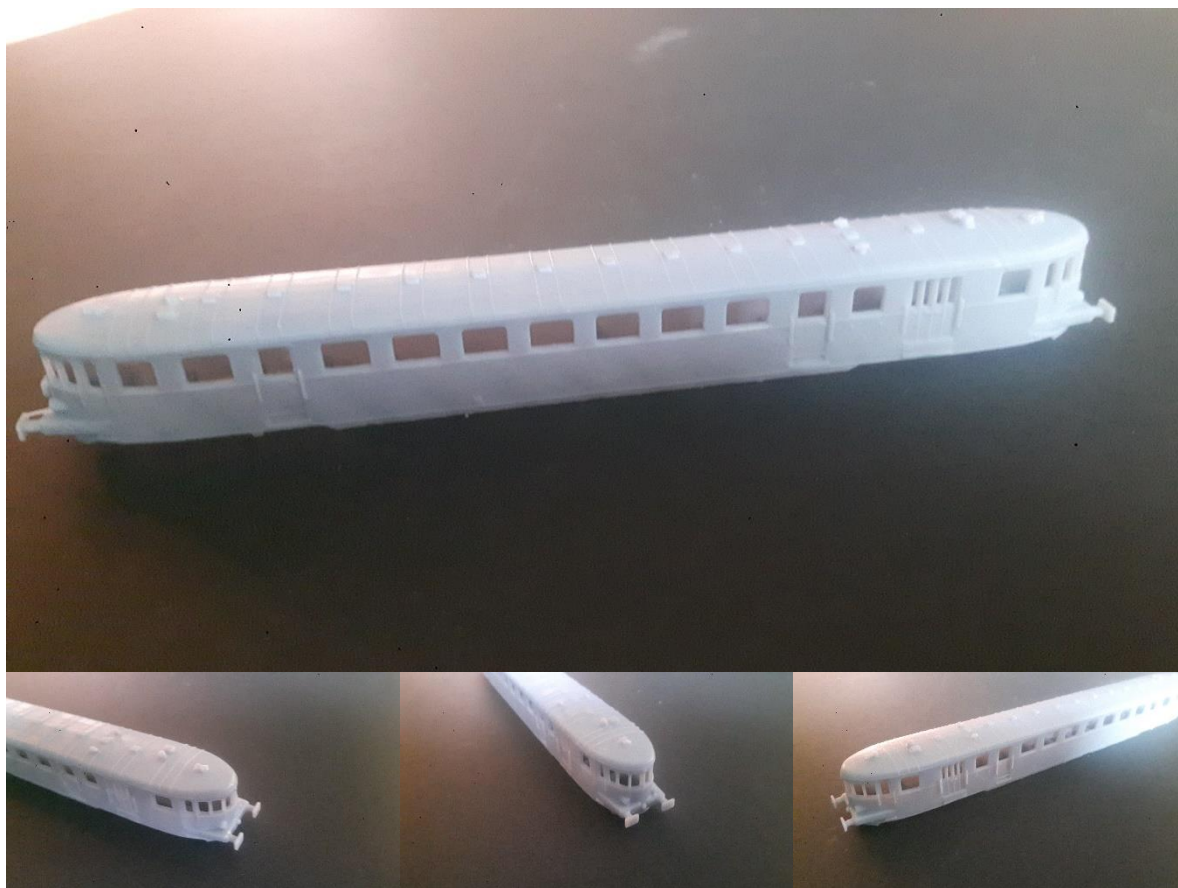

32 €

VH Renault

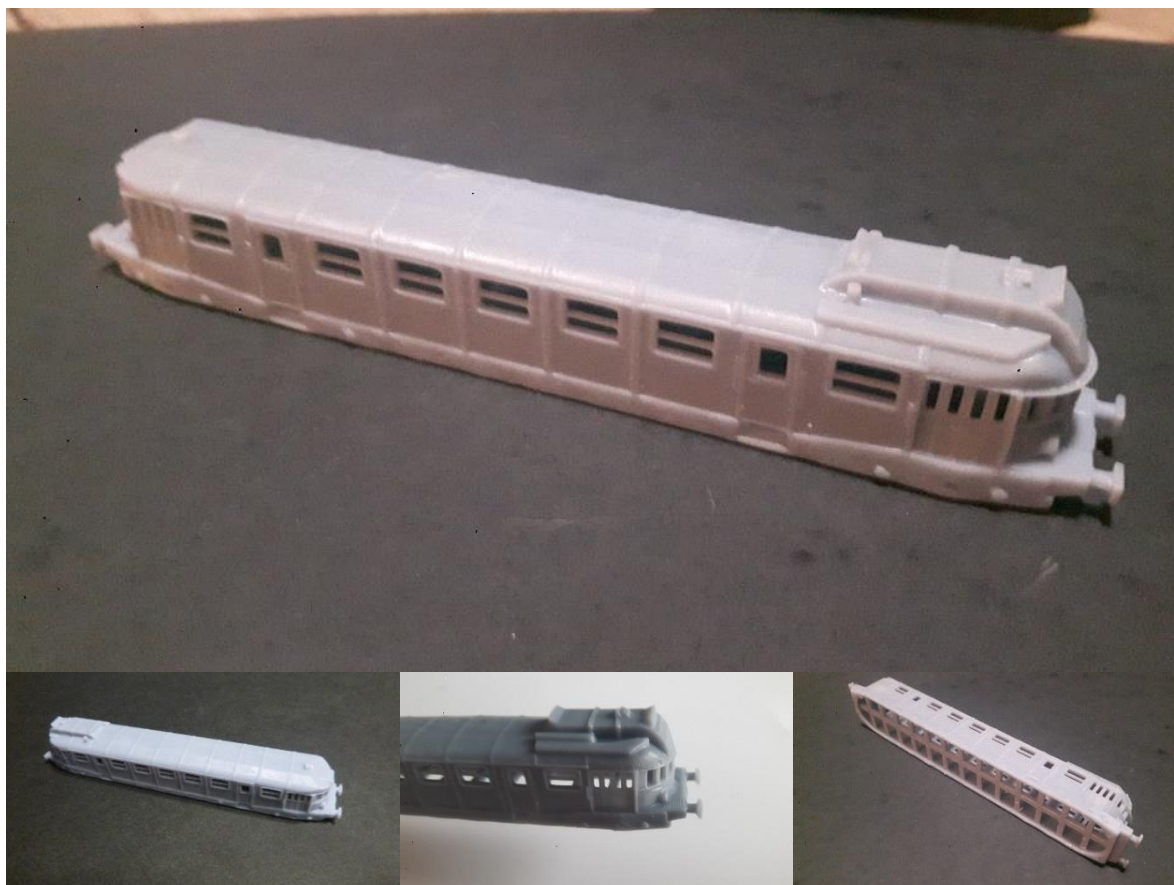

Le VH existe en modèle diorama.

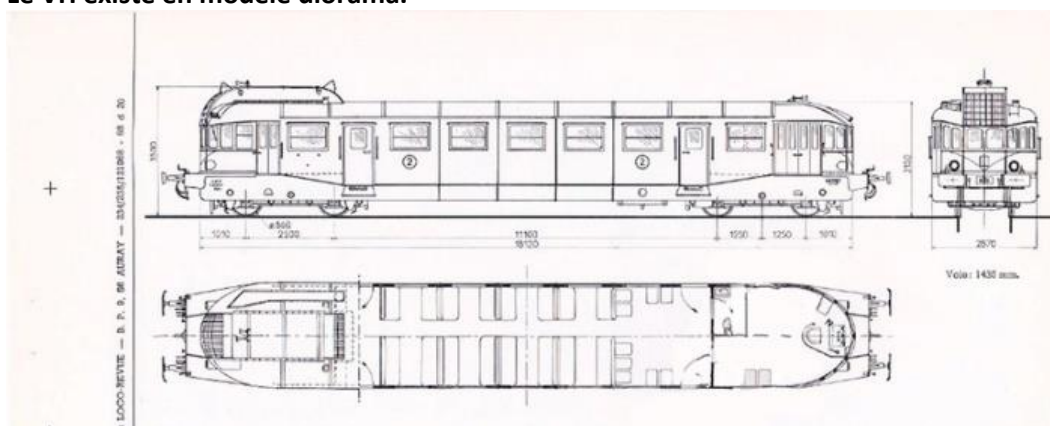

30 €

S.P.A.N

12 rue Alain-fournier

53000 Laval

0619443310 - stpoup1@gmail.com

N°Siret : 891 865 883 00013



VH AL Renault

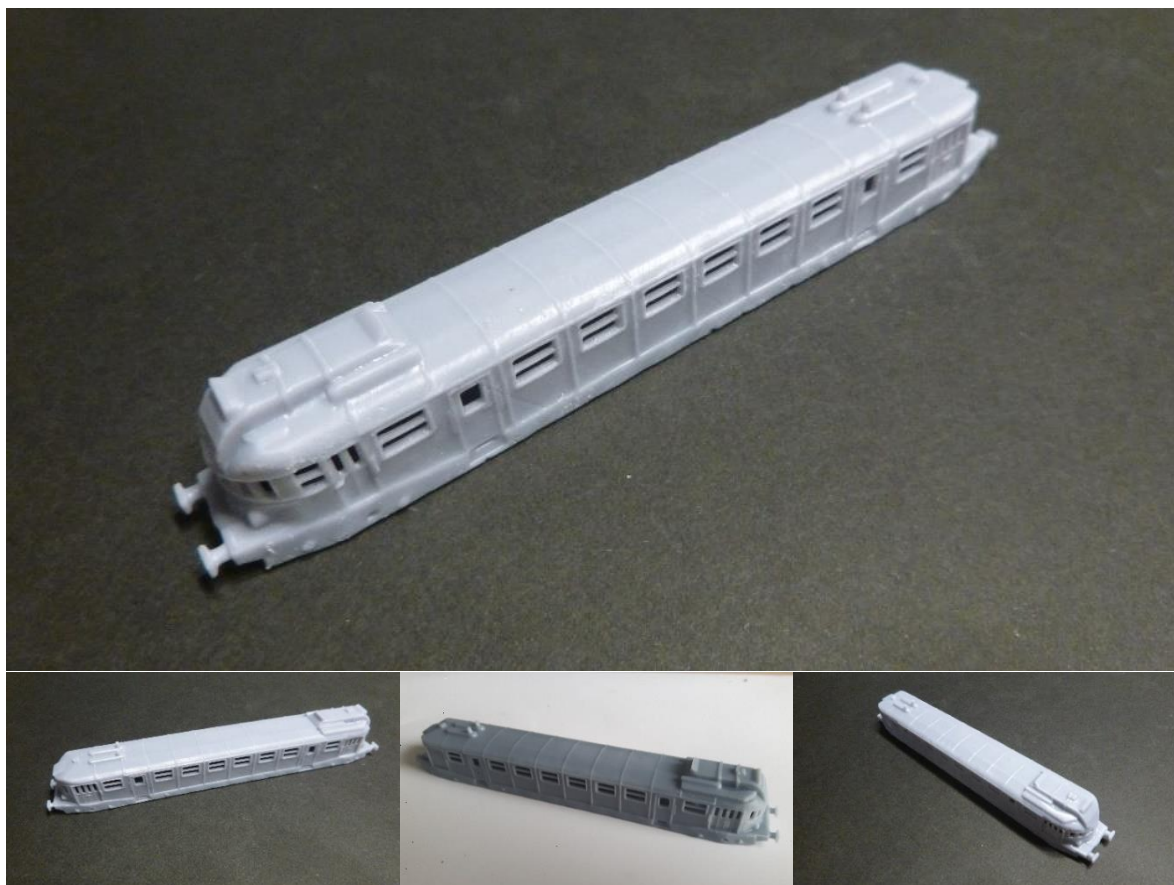

Remarque : Ce modèle est sûr de nombreux points identique au VH, il est un peu plus long et possède 6 fenêtres latérales, contre 5 pour le VH.

30 €**S.P.A.N**

12 rue Alain-fourmier

53000 Laval

0619443310 - stpoup1@gmail.com

N°Siret : 891 865 883 00013

ADN Standard-Nord

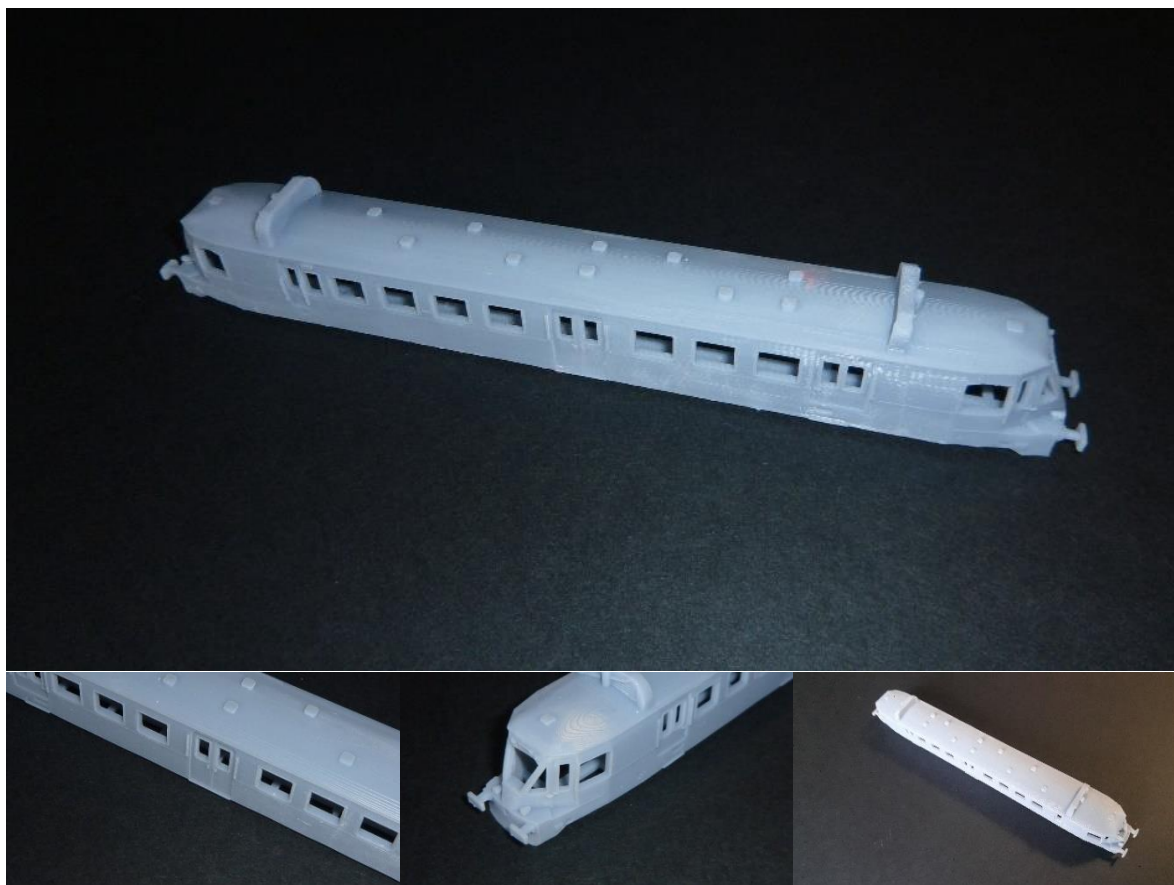

Le modèle Standard-Nord est livré avec les banquettes.

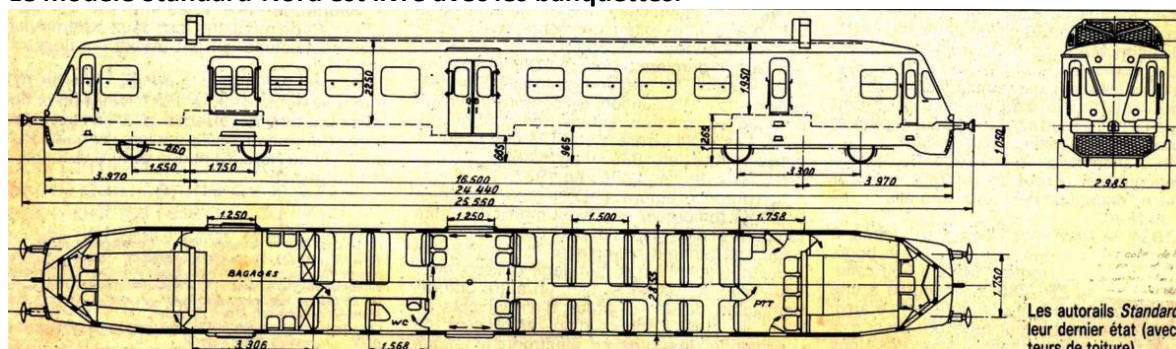

32 €

S.P.A.N

12 rue Alain-fournier

53000 Laval

0619443310 - stpoup1@gmail.com

N°Siret : 891 865 883 00013



Remorque ADN – XR4000 court / long

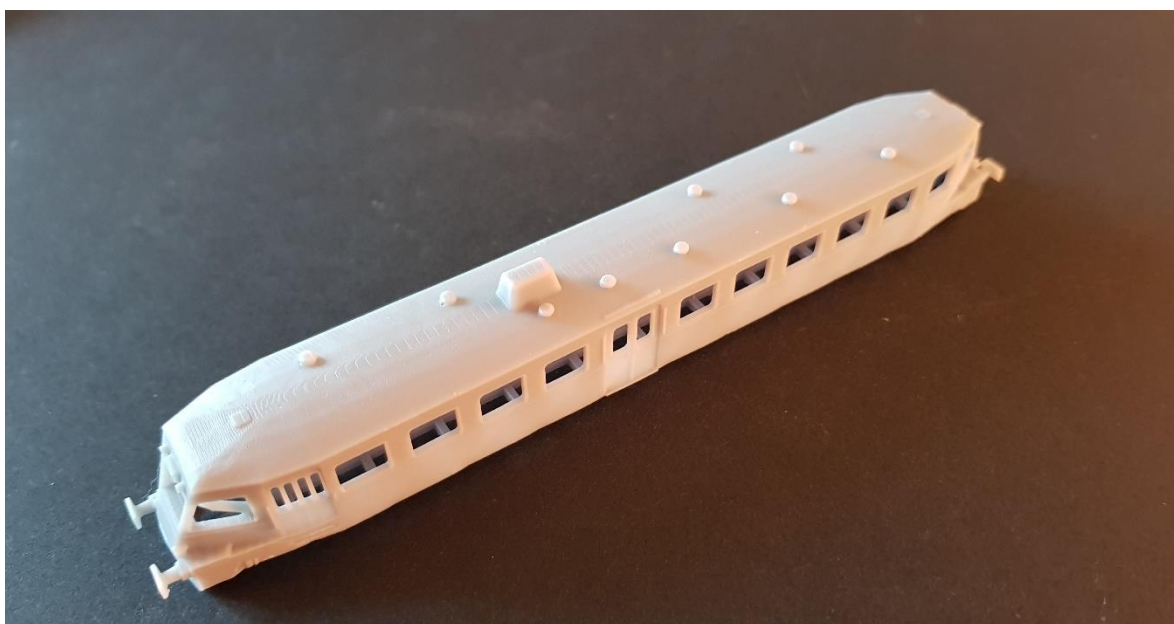

La remorque _____ 30 €

S.P.A.N

12 rue Alain-fourmier

53000 Laval

0619443310 - stpoup1@gmail.com

N°Siret : 891 865 883 00013

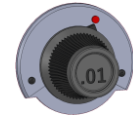

DeDietrich 210cv

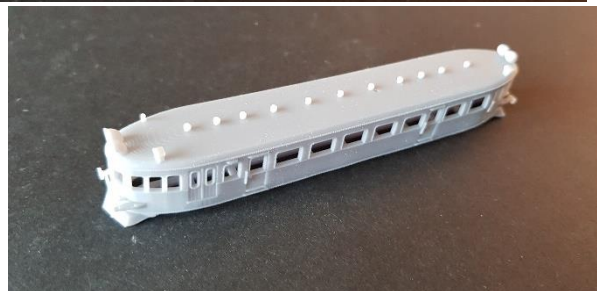
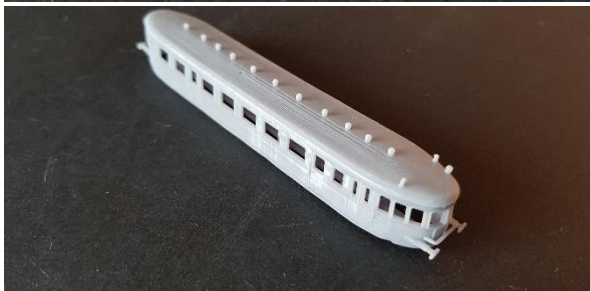
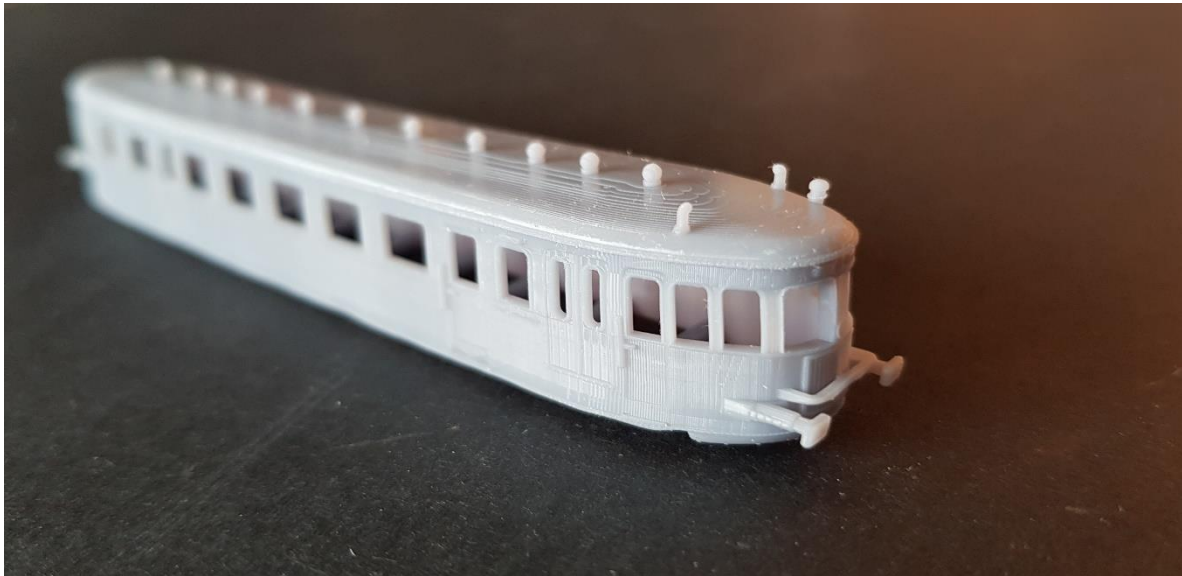

Existe en version libanaise (photo ci-dessus)

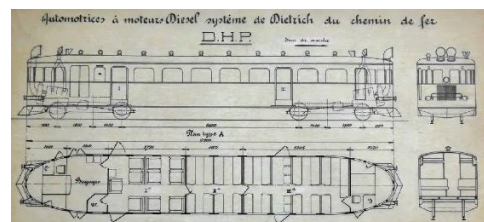

30 €



DeDietrich 270cv « gazo »

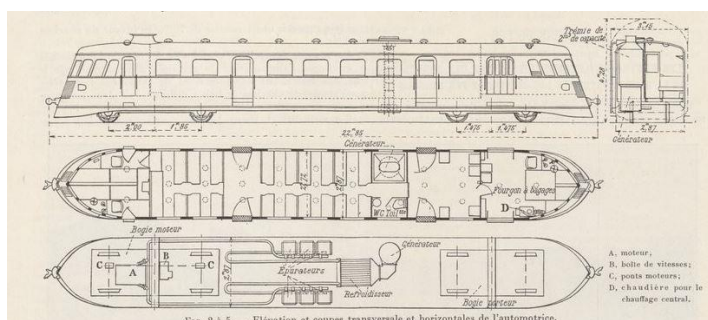
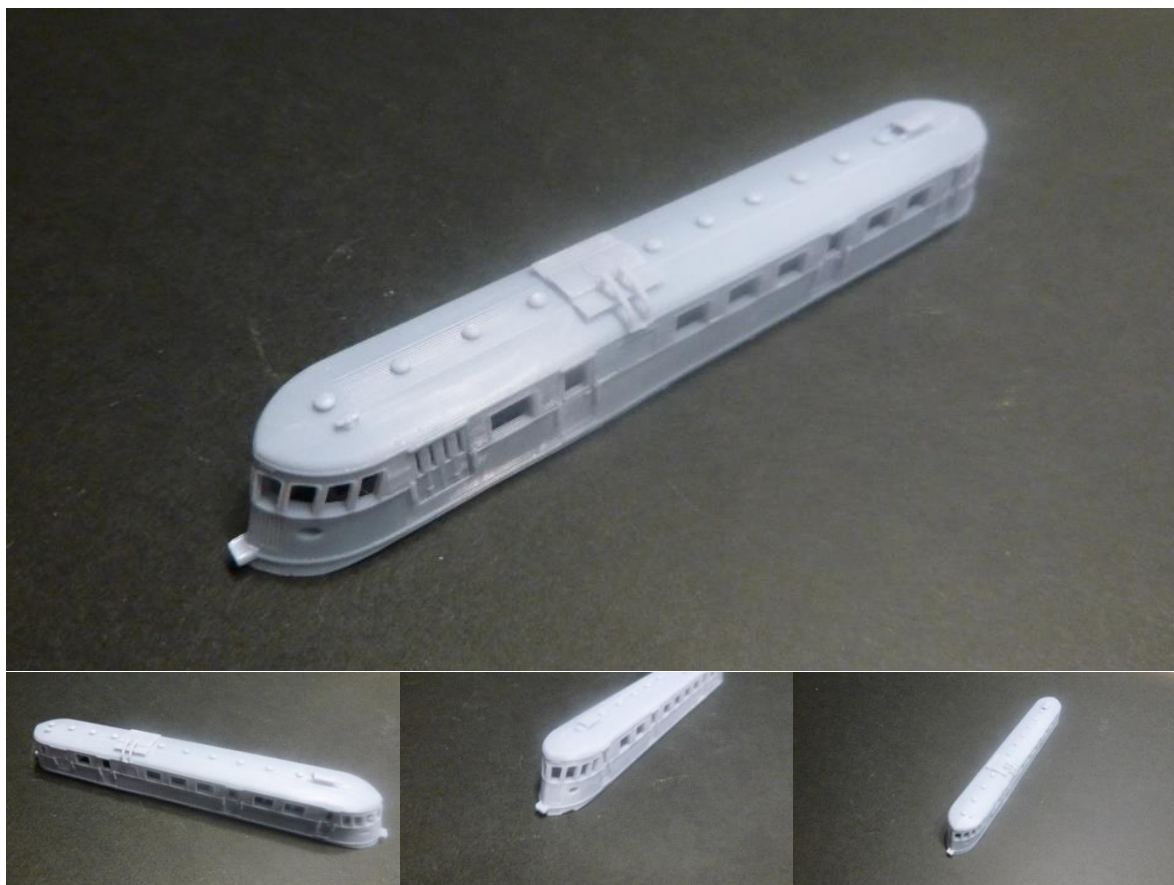

30 €



DeDietrich 500cv

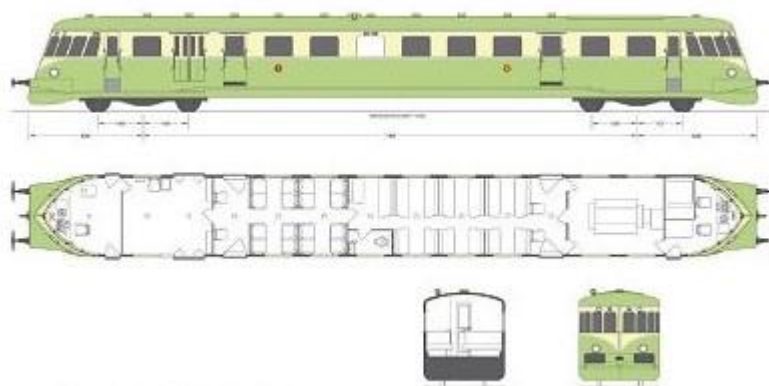
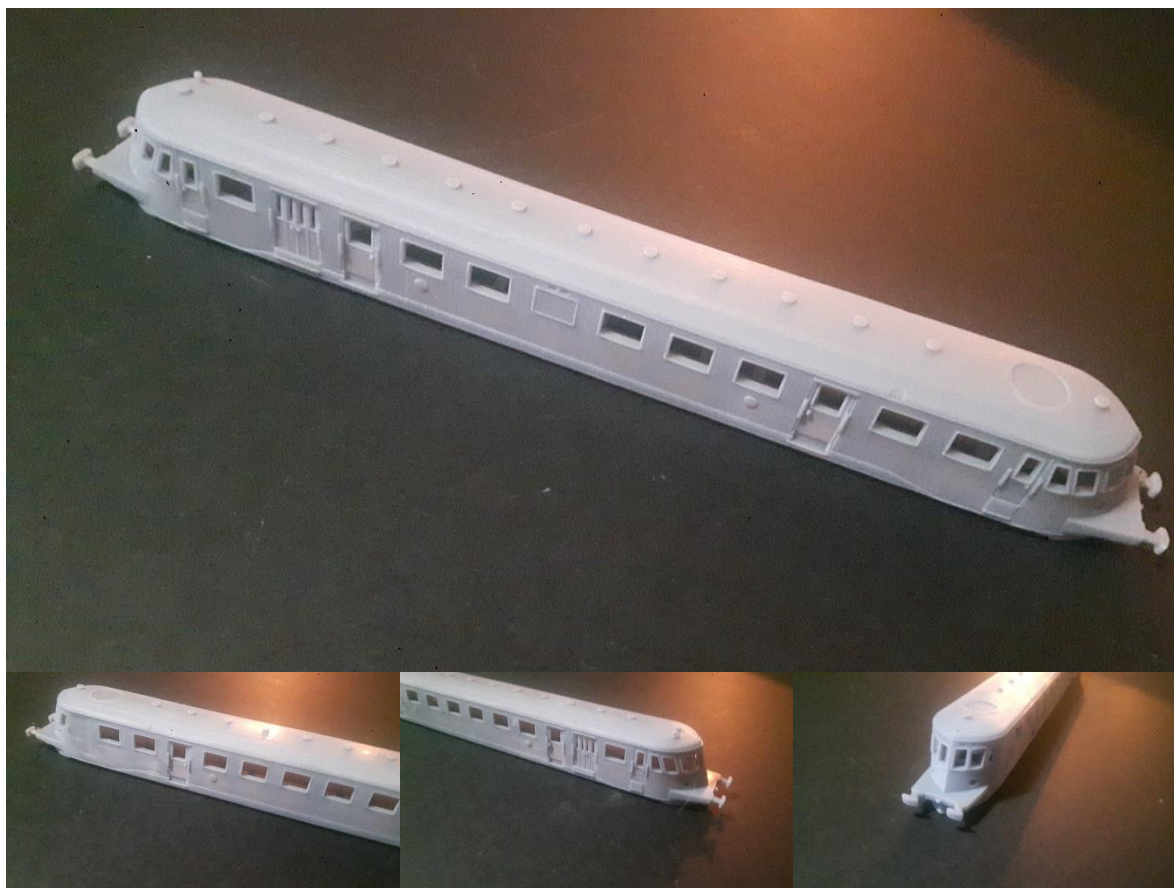

30 €

S.P.A.N

12 rue Alain-fournier

53000 Laval

0619443310 - stpoup1@gmail.com

N°Siret : 891 865 883 00013



CC40100

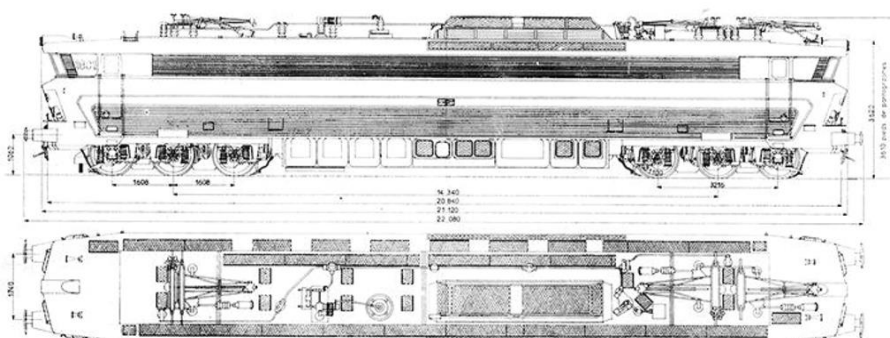
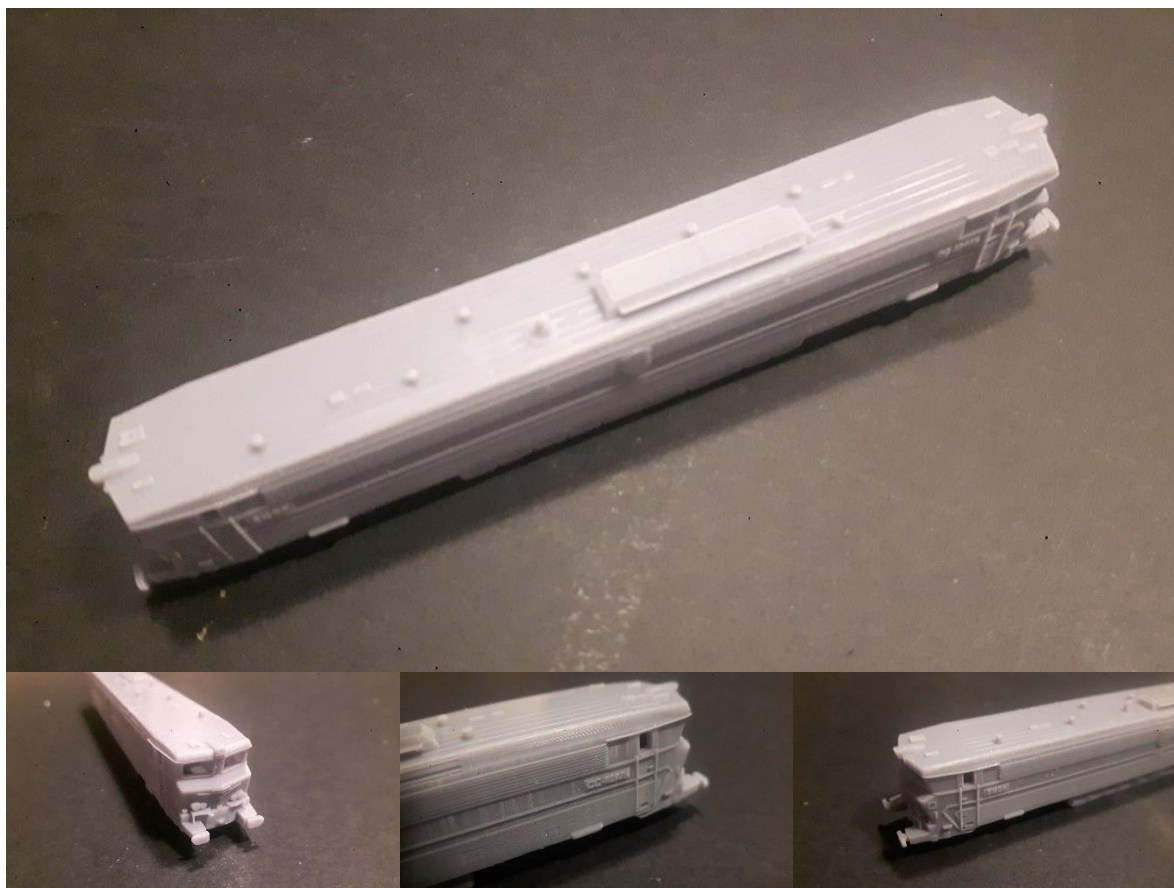

30 €

S.P.A.N

12 rue Alain-fourmier

53000 Laval

0619443310 - stpoup1@gmail.com

N°Siret : 891 865 883 00013



CC65000

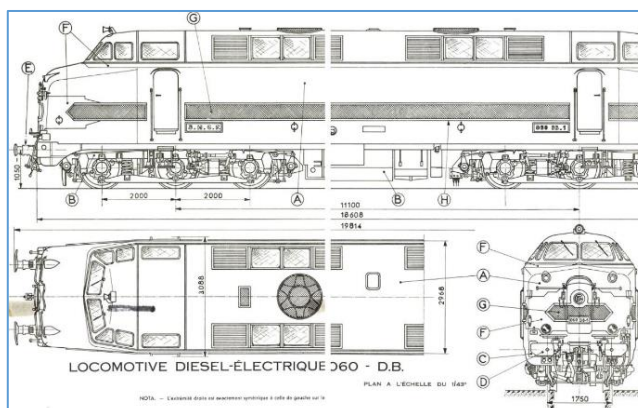

30 €

S.P.A.N

12 rue Alain-fournier

53000 Laval

0619443310 - stpoup1@gmail.com

N°Siret : 891 865 883 00013



CC72000

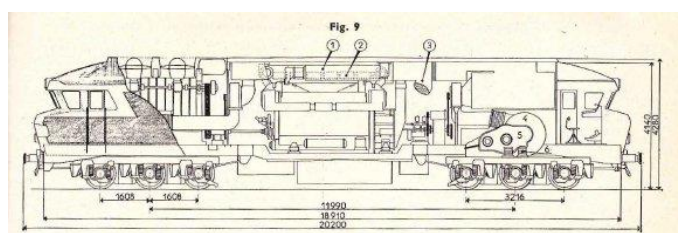
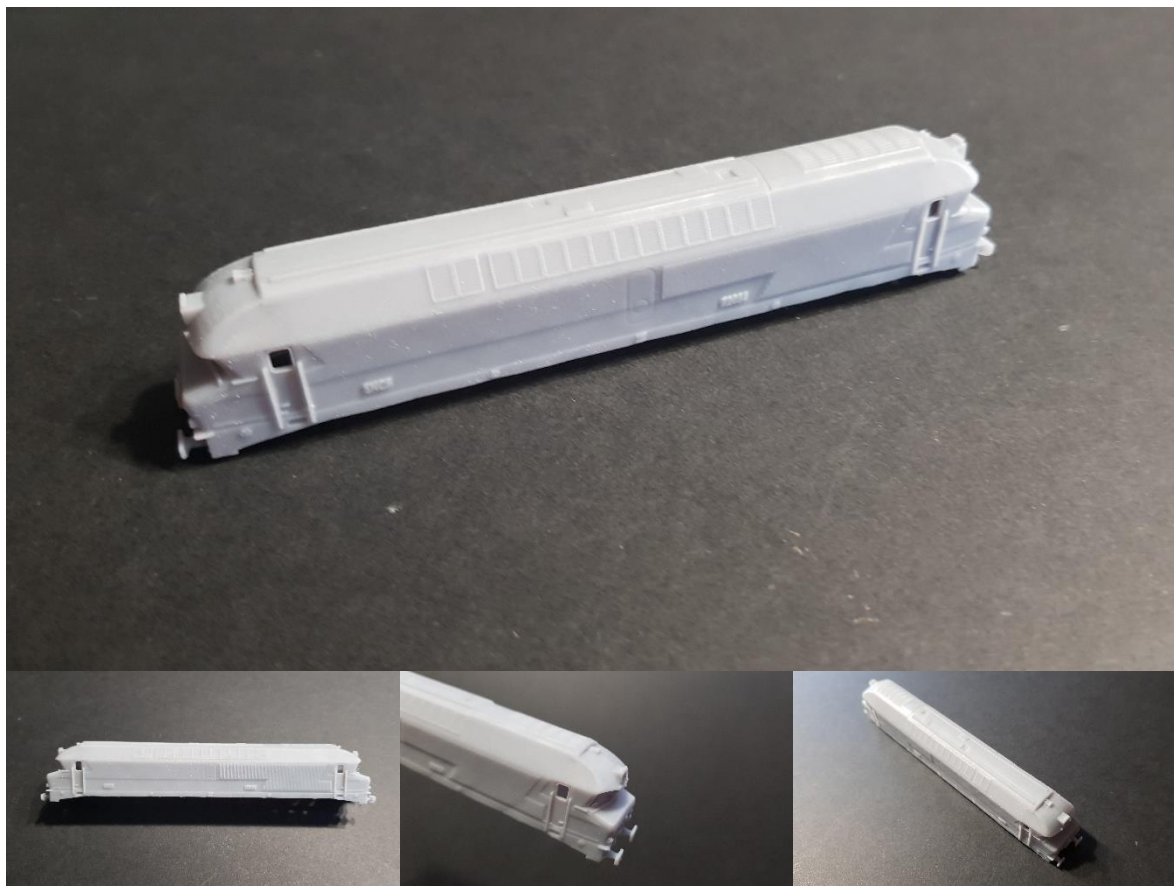

30 €

S.P.A.N

12 rue Alain-fourmier

53000 Laval

0619443310 - stpoup1@gmail.com

N°Siret : 891 865 883 00013



ADX

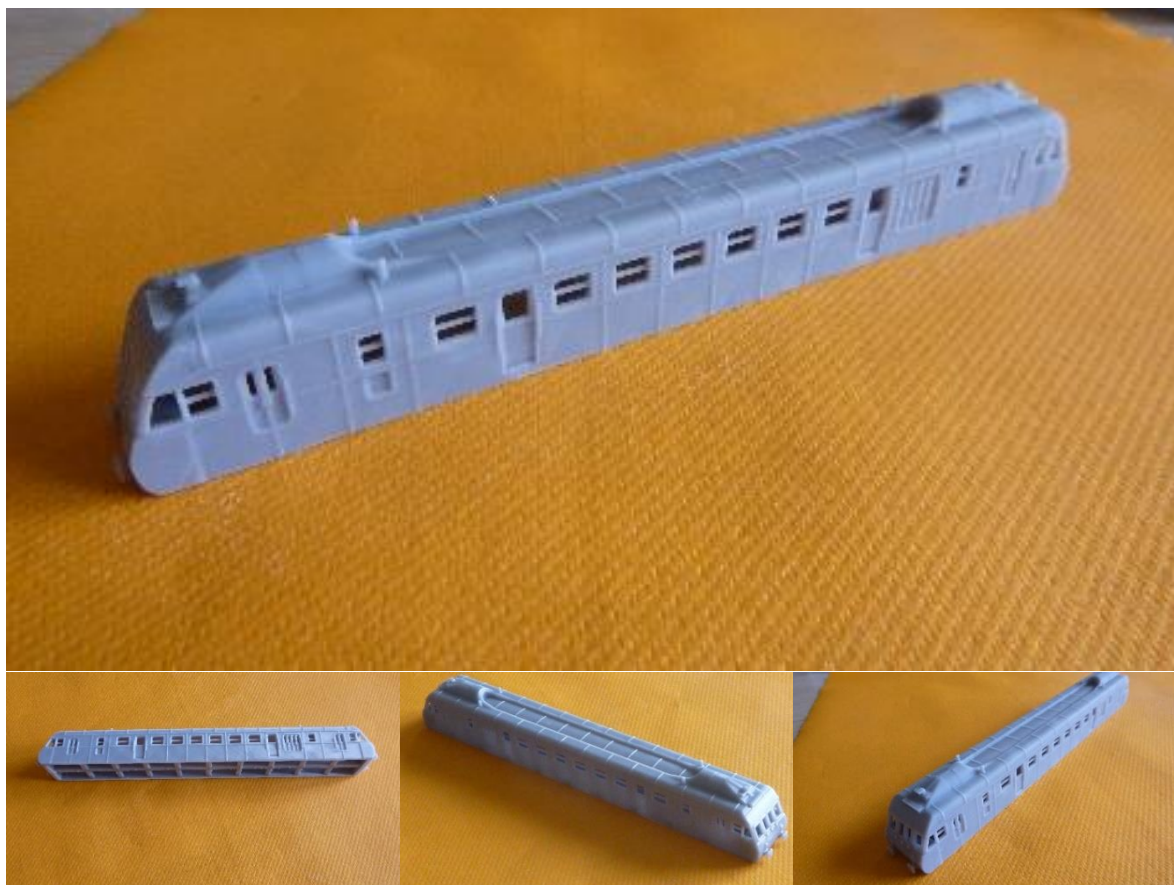

L'ADX est livré avec les banquettes.

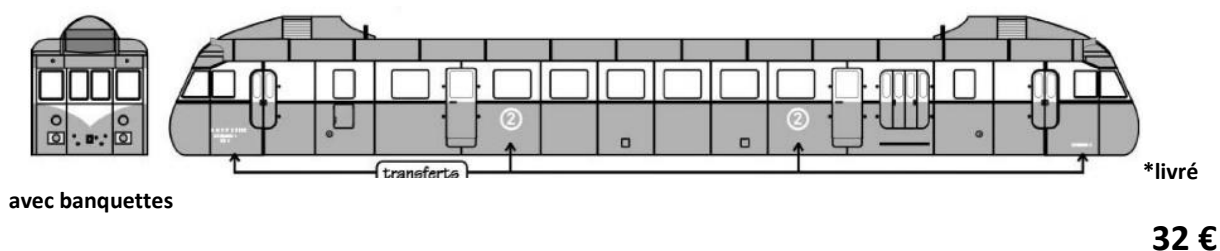

S.P.A.N

12 rue Alain-fournier

53000 Laval

0619443310 - stpoup1@gmail.com

N°Siret : 891 865 883 00013

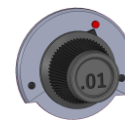

ABV (rame 2 éléments)

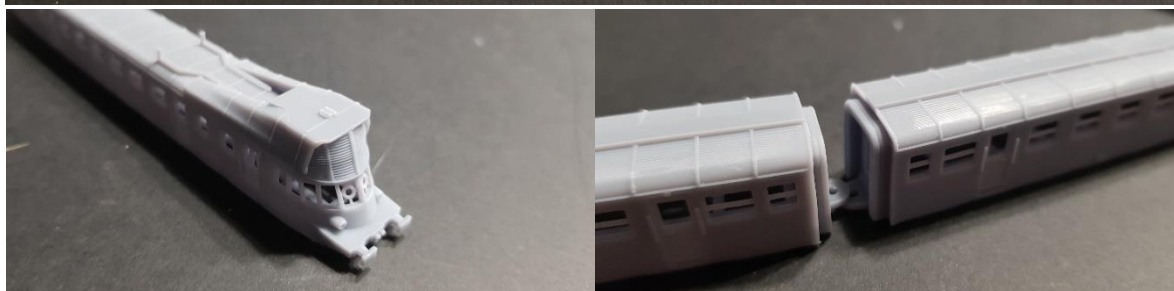

60€

S.P.A.N

12 rue Alain-fournier

53000 Laval

0619443310 - stpoup1@gmail.com

N°Siret : 891 865 883 00013



ABJ

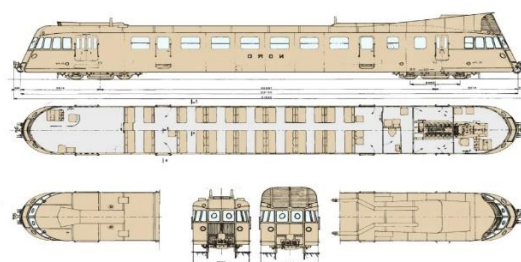
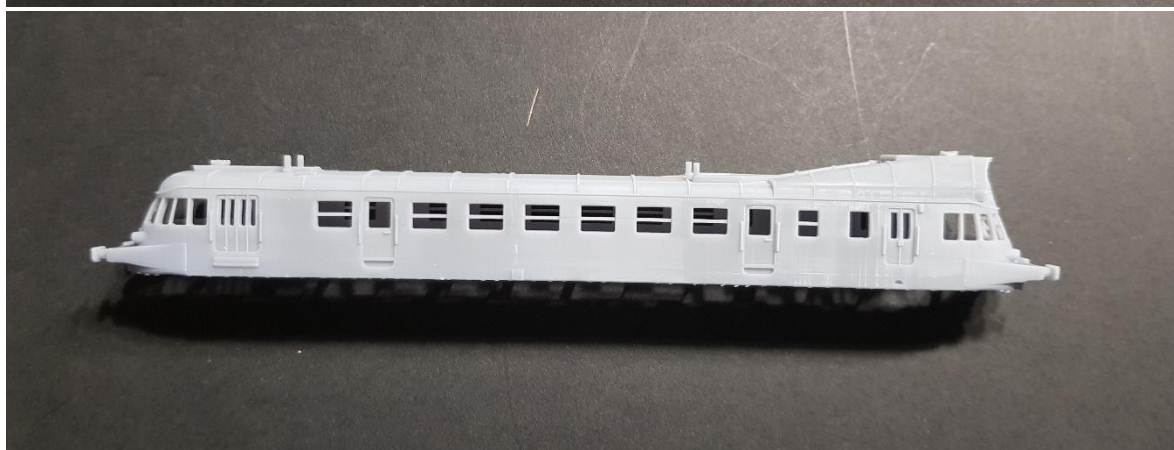
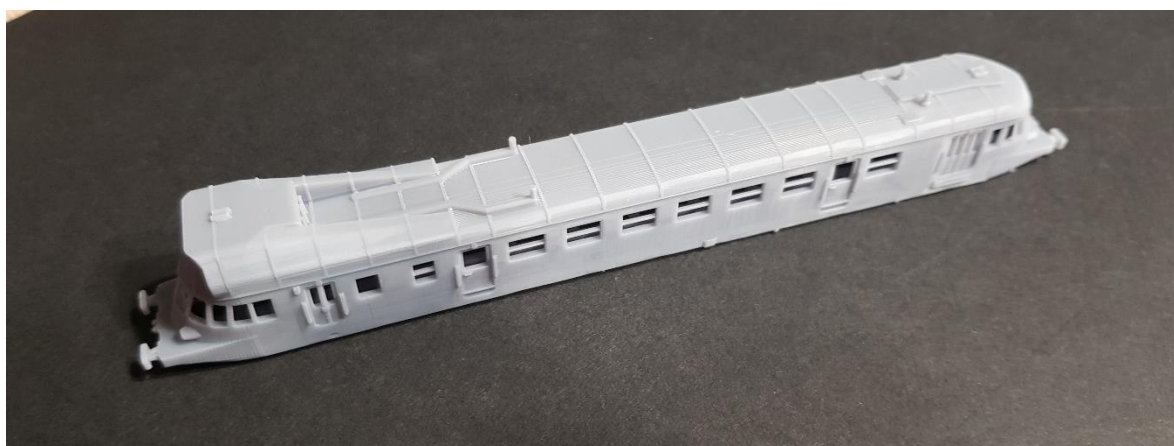

32 €

S.P.A.O.

12 rue Alain-fourmier

53000 Laval

0619443310 - stpoup1@gmail.com

N°Siret : 891 865 883 00013



AEK2

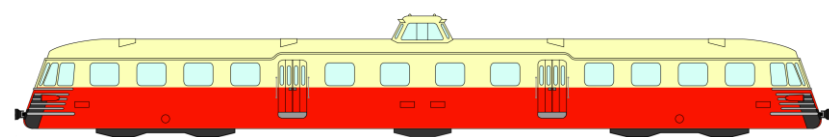
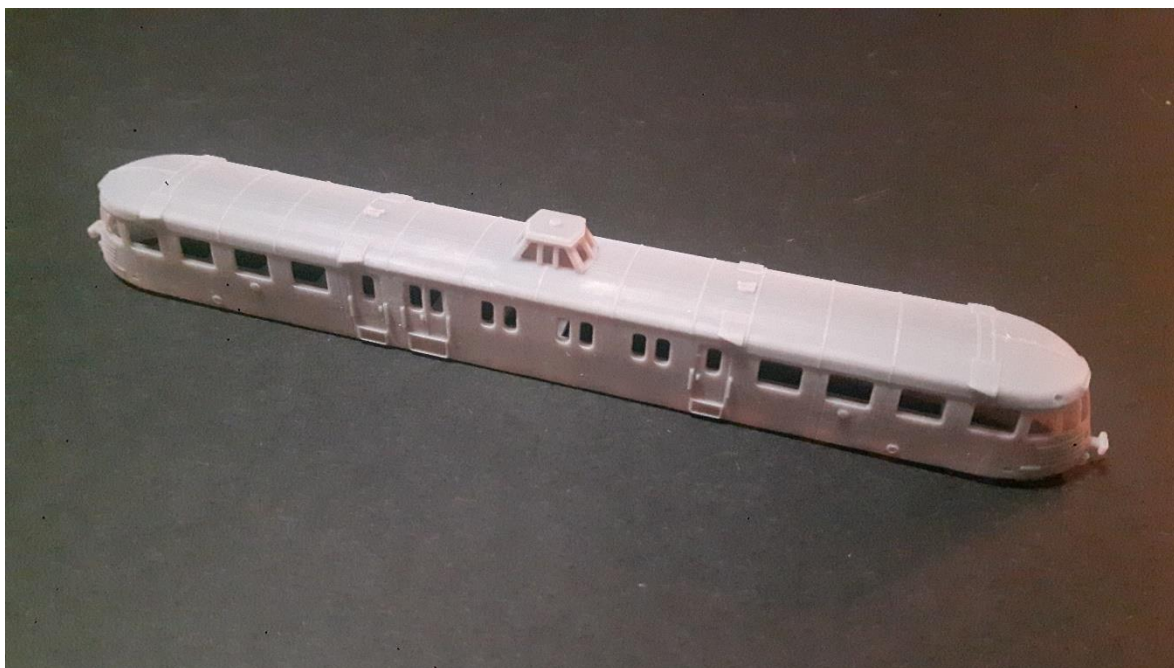

32 €



BUGATTI Présidentiel



Le Bugatti Présidentiel est livré avec les banquettes, il existe en modèle diorama.

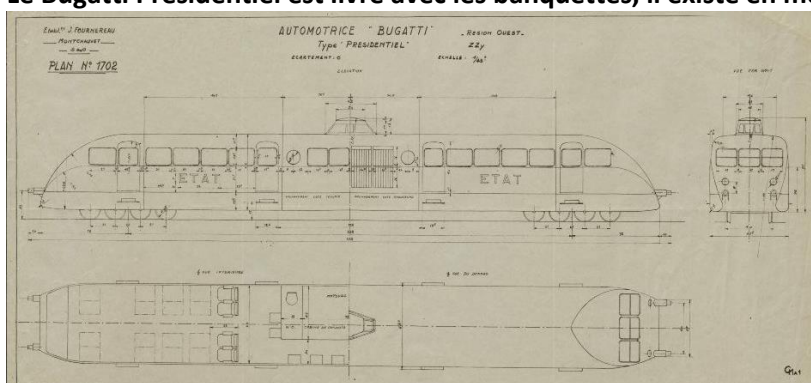

32 €



BUGATTI double WR (2 éléments)



Le Bugatti WR existe en modèle diorama.

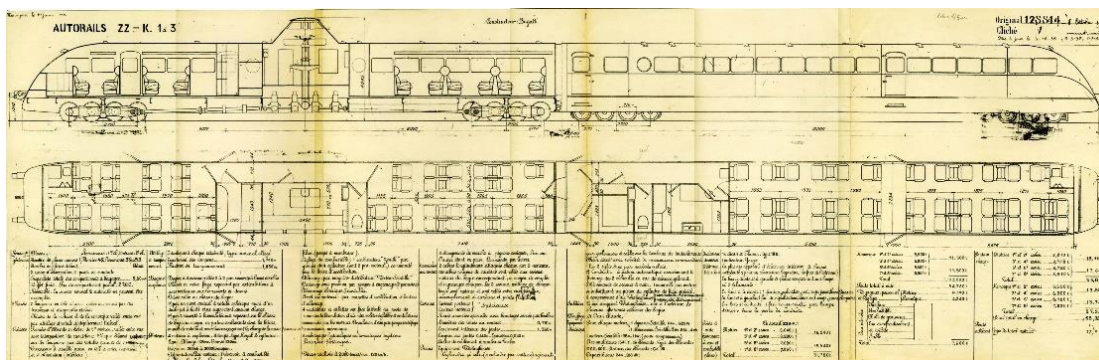

55 €

S.P.A.N

12 rue Alain-fournier

53000 Laval

0619443310 - stpoup1@gmail.com

N°Siret : 891 865 883 00013



BUGATTI Triple (3 éléments)

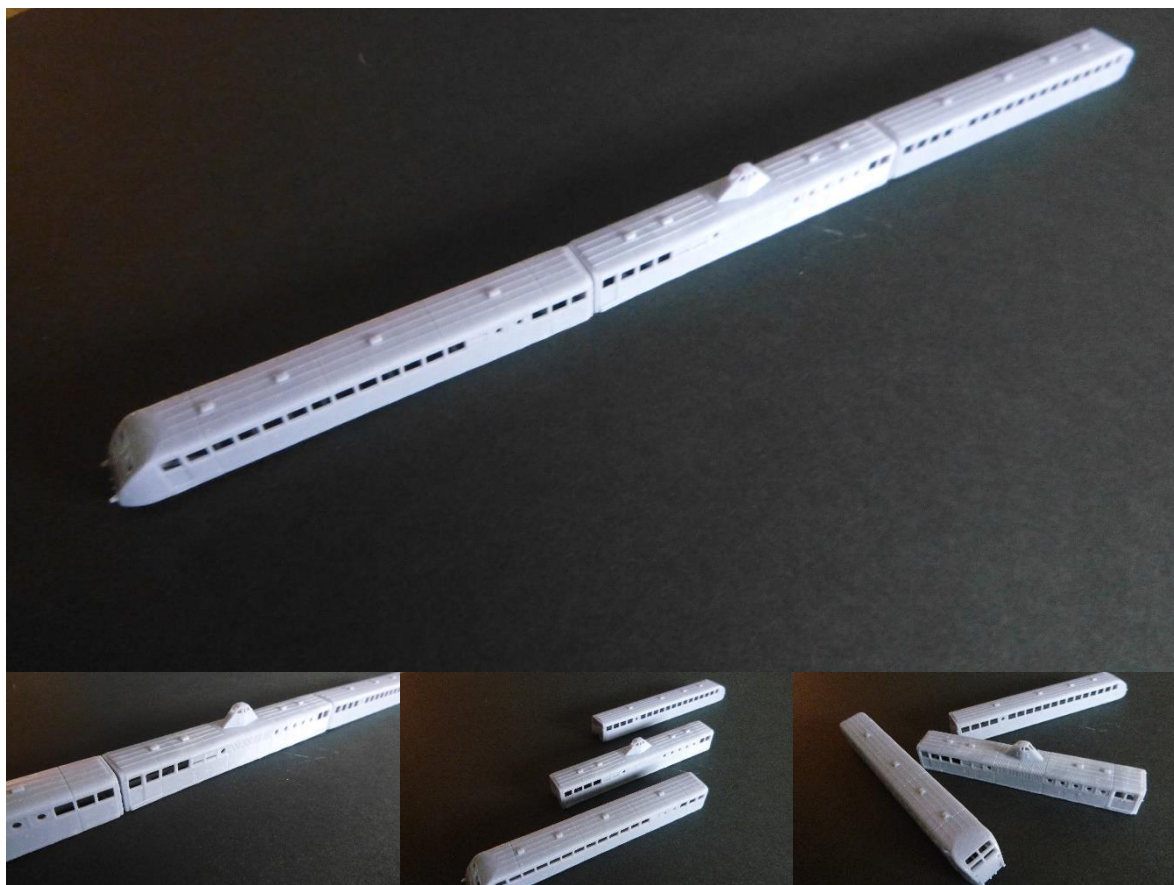

Le Bugatti WR existe en modèle diorama.

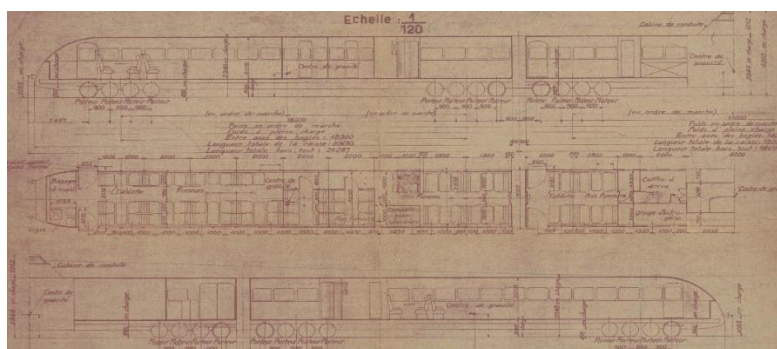

75 €

S.P.A.N

12 rue Alain-fournier

53000 Laval

0619443310 - stpoup1@gmail.com

N°Siret : 891 865 883 00013

Rame Z5100 (3 éléments)

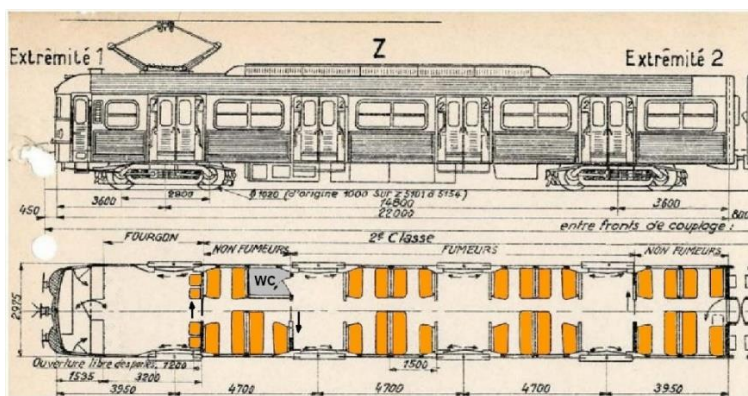
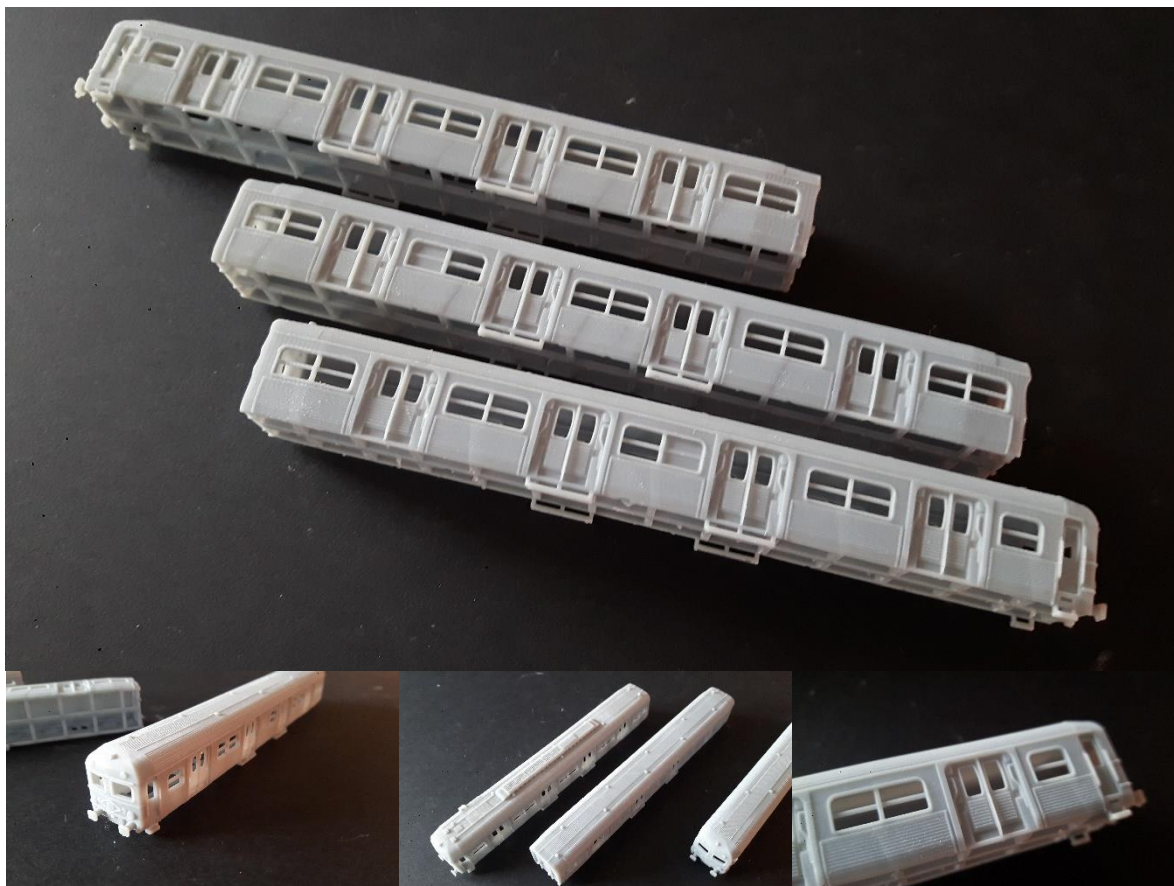

75 €

S.P.A.N

12 rue Alain-fournier

53000 Laval

0619443310 - stpoup1@gmail.com

N°Siret : 891 865 883 00013



Rame TAR34 (3 éléments)

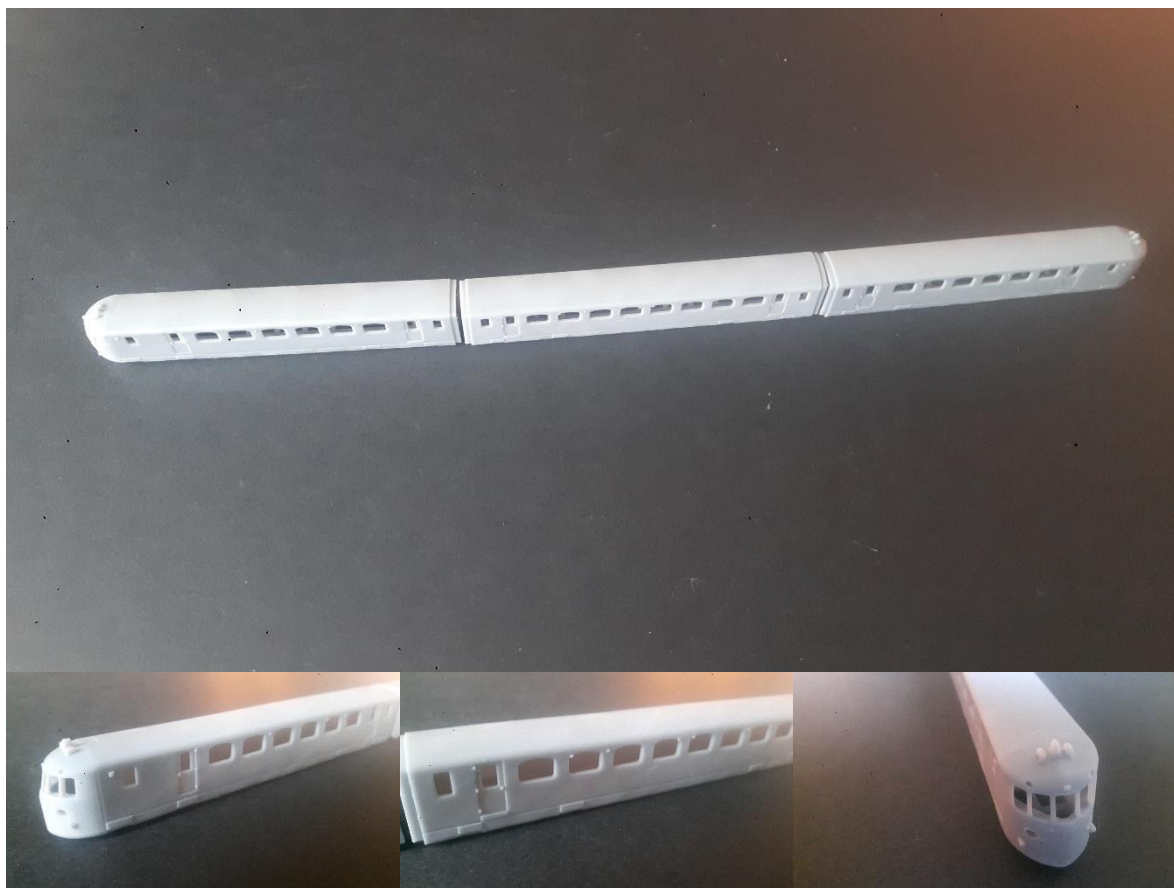

75 €

S.P.A.O.

12 rue Alain-fournier

53000 Laval

0619443310 - stpoup1@gmail.com

N°Siret : 891 865 883 00013



Rame ETG (4 éléments)

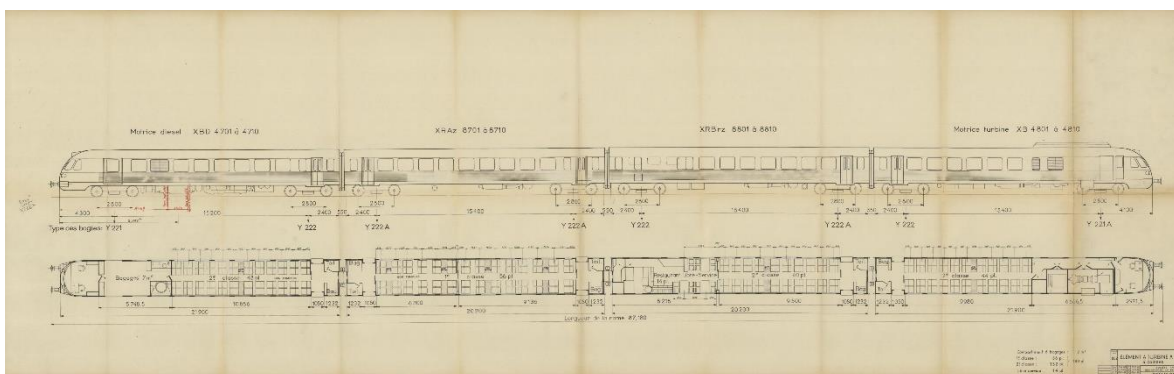

100 €

S.P.A.N

12 rue Alain-fourmier

53000 Laval

0619443310 - stpoup1@gmail.com

N°Siret : 891 865 883 00013



Rame « Saucisson » (2 éléments)

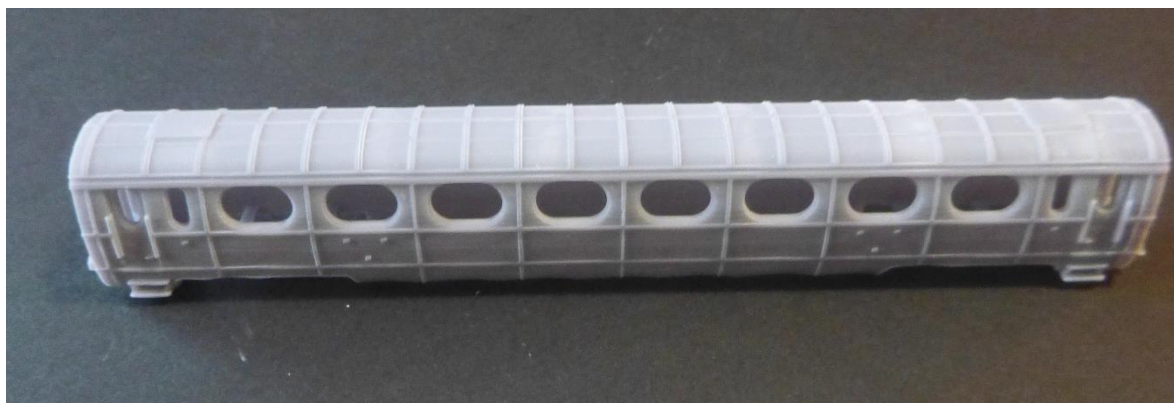

Possibilité de vente au détail (wagon ou fourgon à 28€)



50€



Rame « MISTRAL » (3 éléments)

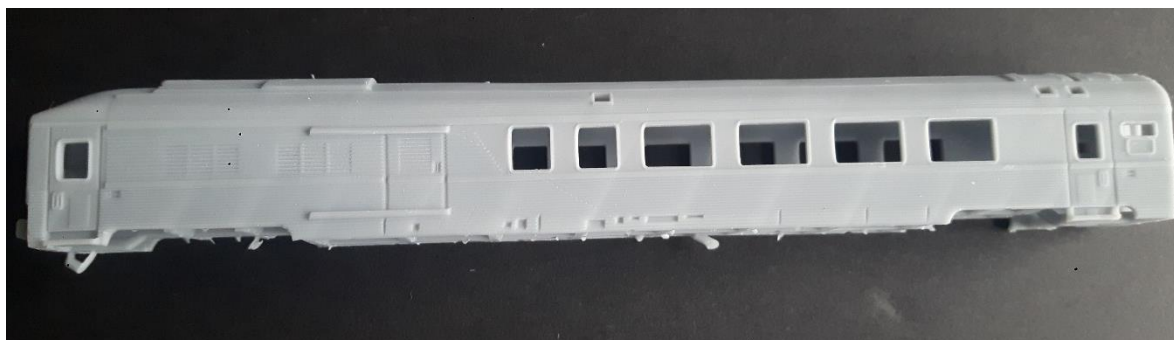

Possibilité de vente au détail (wagon ou fourgon à 28€)



75€

S.P.A.O.

12 rue Alain-fournier

53000 Laval

0619443310 - stpoup1@gmail.com

N°Siret : 891 865 883 00013



Rame « X72500 » (3 éléments)



75€

S.P.A.N

12 rue Alain-fournier

53000 Laval

0619443310 - stpoup1@gmail.com

N°Siret : 891 865 883 00013



Rame « X76500 » (3 éléments)

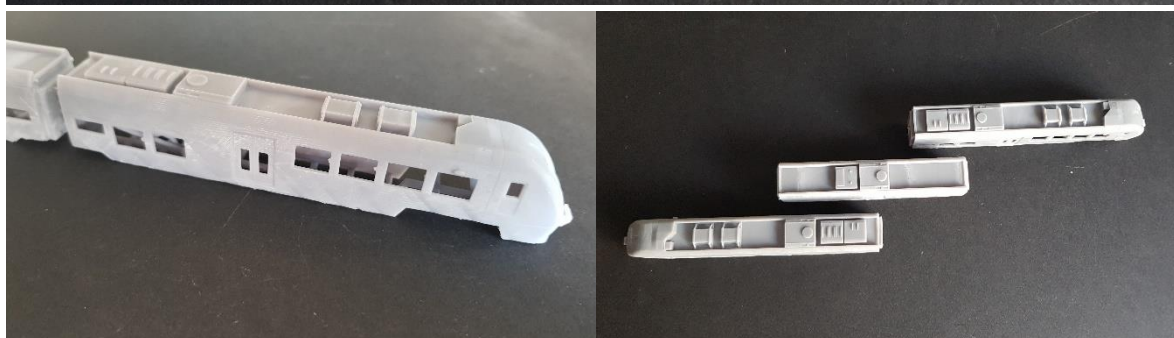

75€



Rame RRR Carel -Fouché (3 éléments)

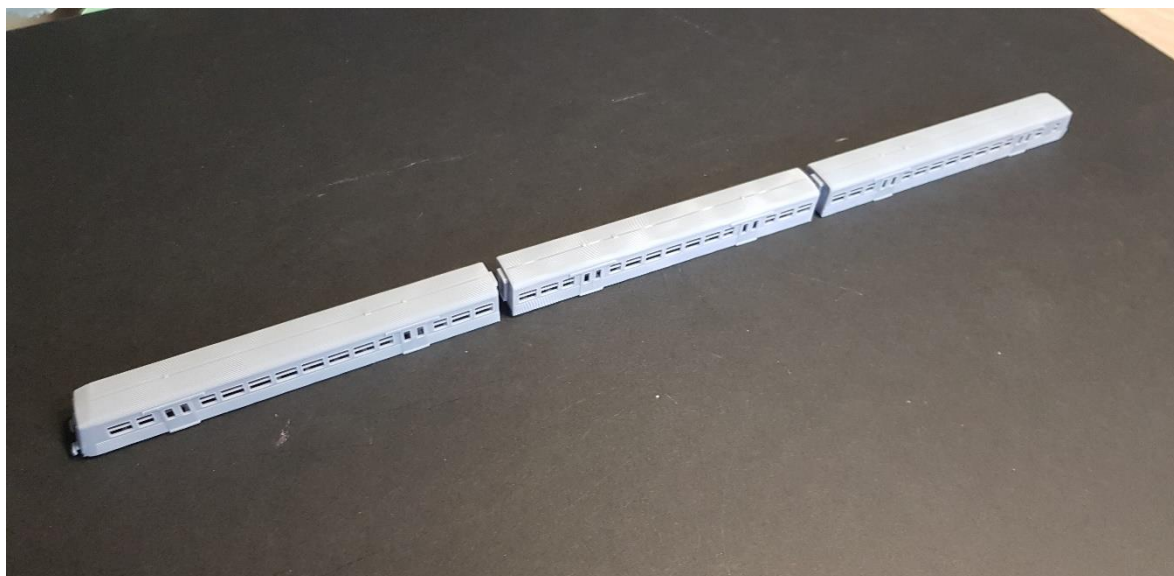

75€

Autorail « Pauline »

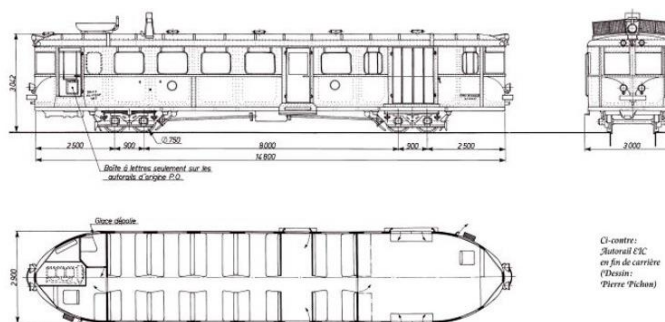
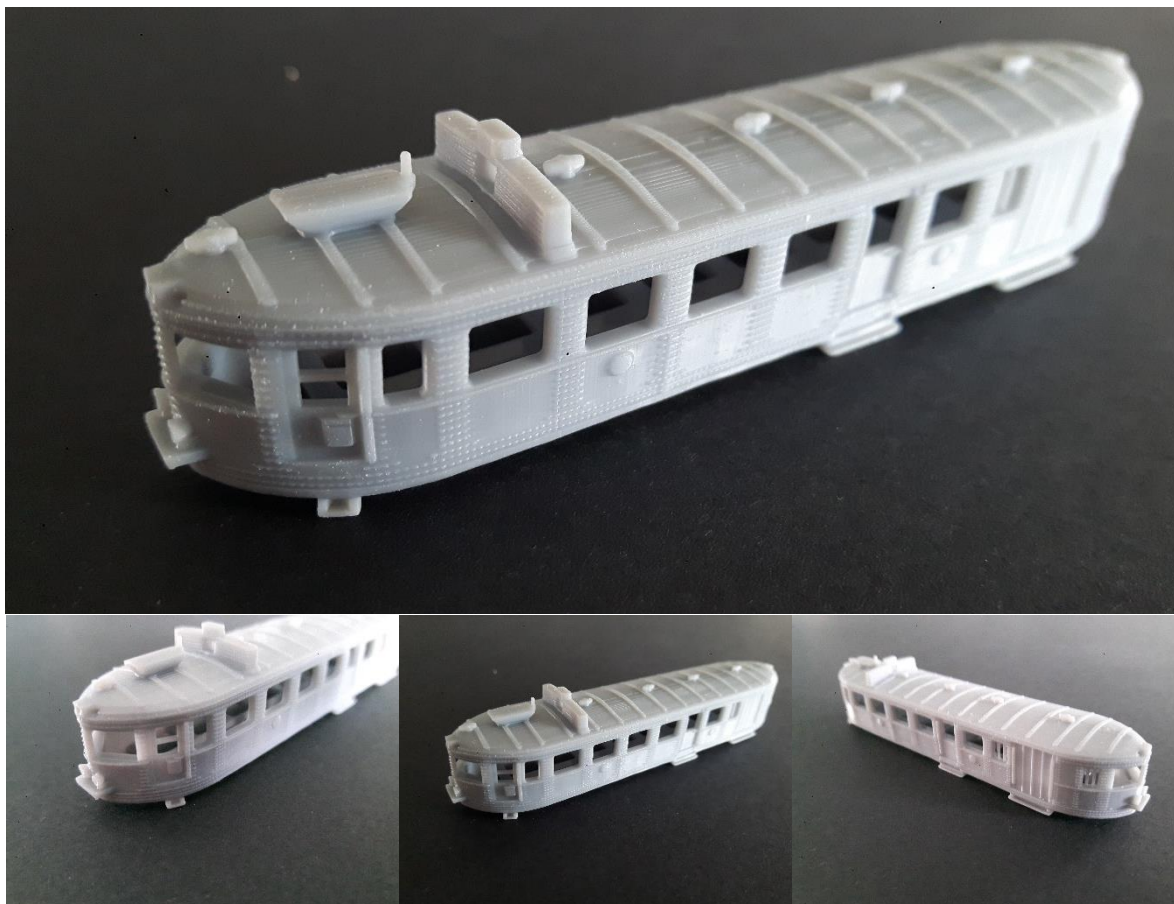

30 €



Autorail Renault Z0

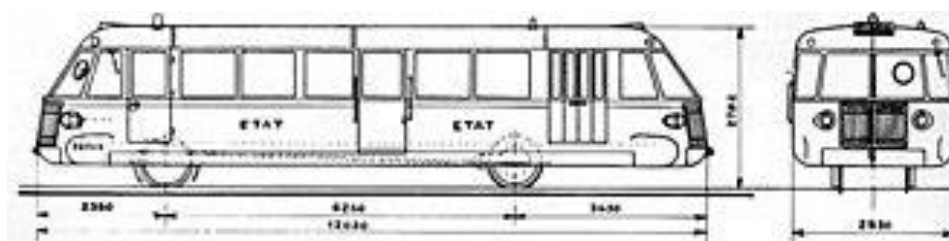

25 €



Autorail FOUGA-DUNLOP

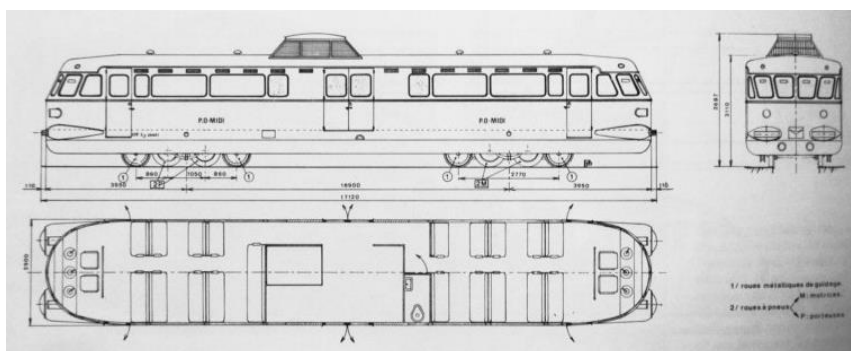

30 €

S.P.A.N

12 rue Alain-fourmier

53000 Laval

0619443310 - stpoup1@gmail.com

N°Siret : 891 865 883 00013



Voiture pilote Corail

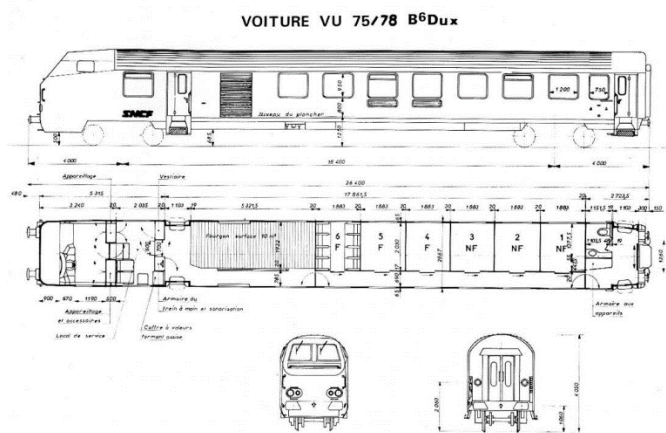

30 €

S.P.A.N

12 rue Alain-fournier

53000 Laval

0619443310 - stpoup1@gmail.com

N°Siret : 891 865 883 00013



Voiture pilote TER 200



30 €



Micheline type 15 - Est

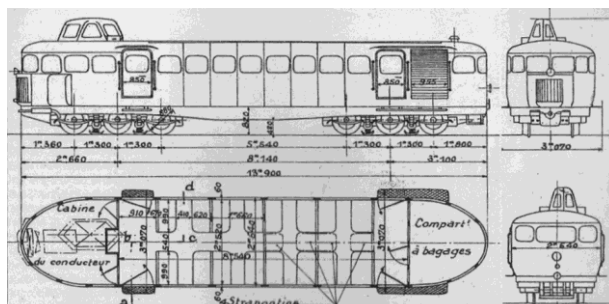
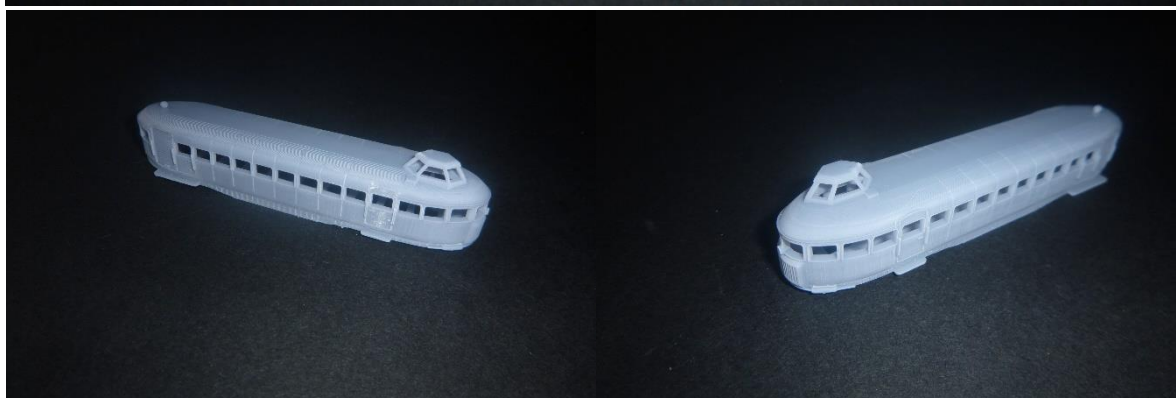
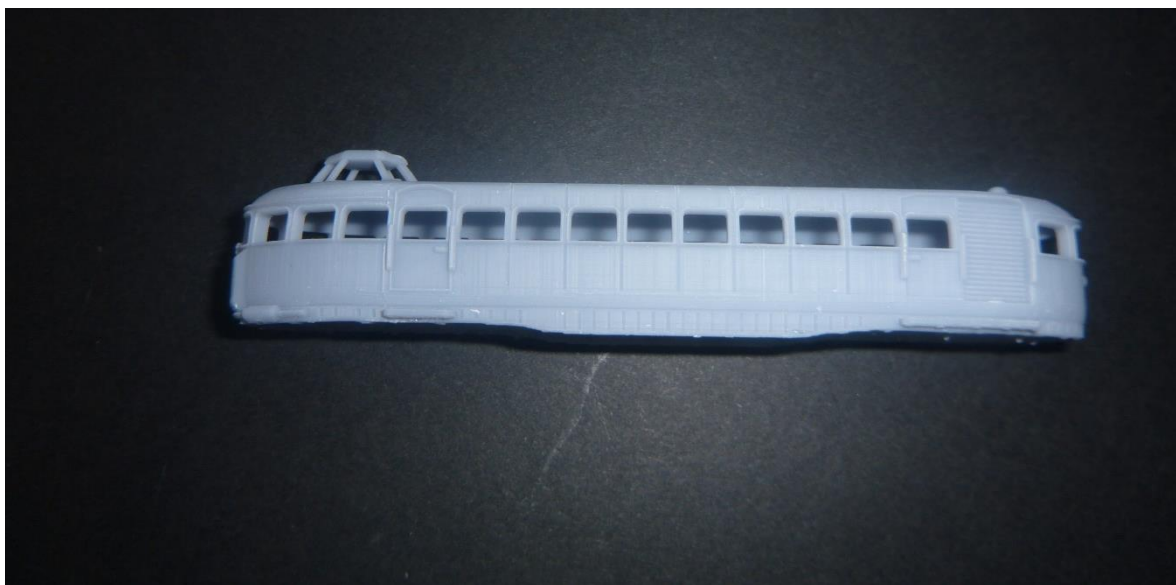

25 €

S.P.A.N

12 rue Alain-fournier

53000 Laval

0619443310 - stpoup1@gmail.com

N°Siret : 891 865 883 00013

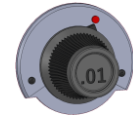

Micheline type 17

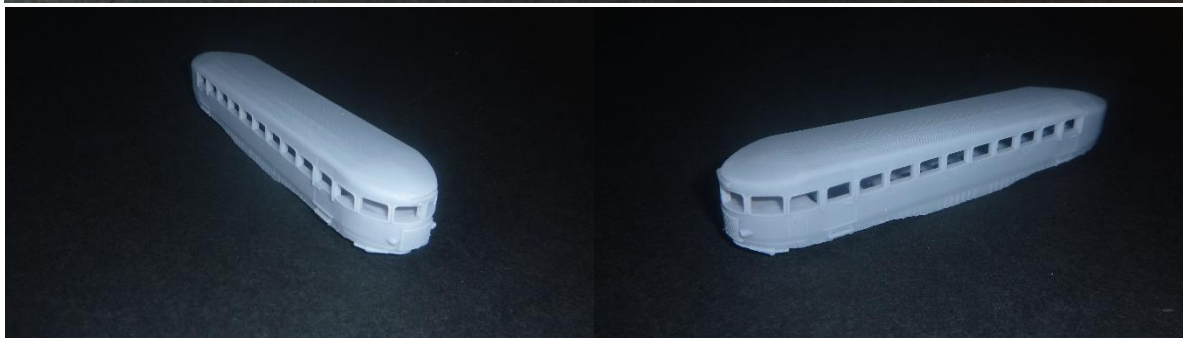

25 €

S.P.A.N

12 rue Alain-fournier

53000 Laval

0619443310 - stpoup1@gmail.com

N°Siret : 891 865 883 00013



Micheline type 23



25 €



DE DION BOUTON - OC1

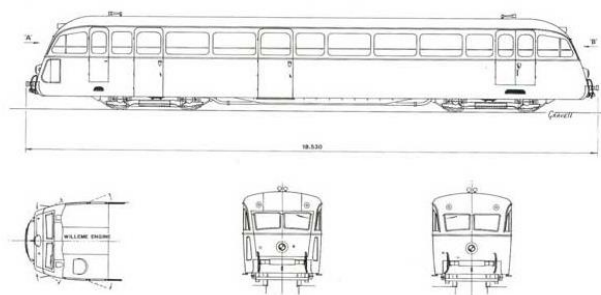
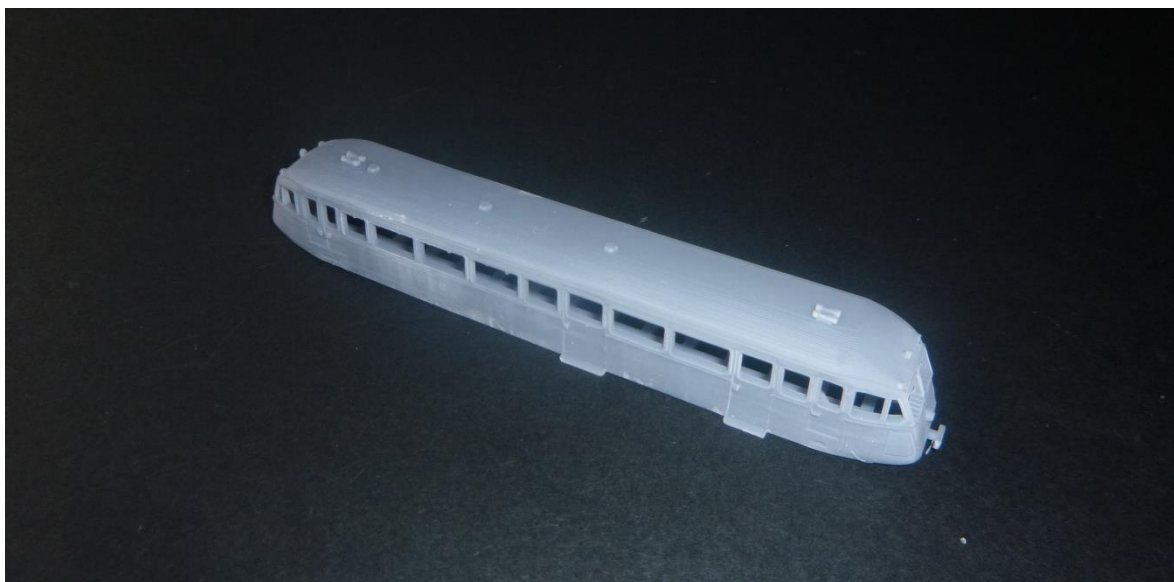

30 €

S.P.A.N

12 rue Alain-fournier

53000 Laval

0619443310 - stpoup1@gmail.com

N°Siret : 891 865 883 00013



DE DION BOUTON – OR

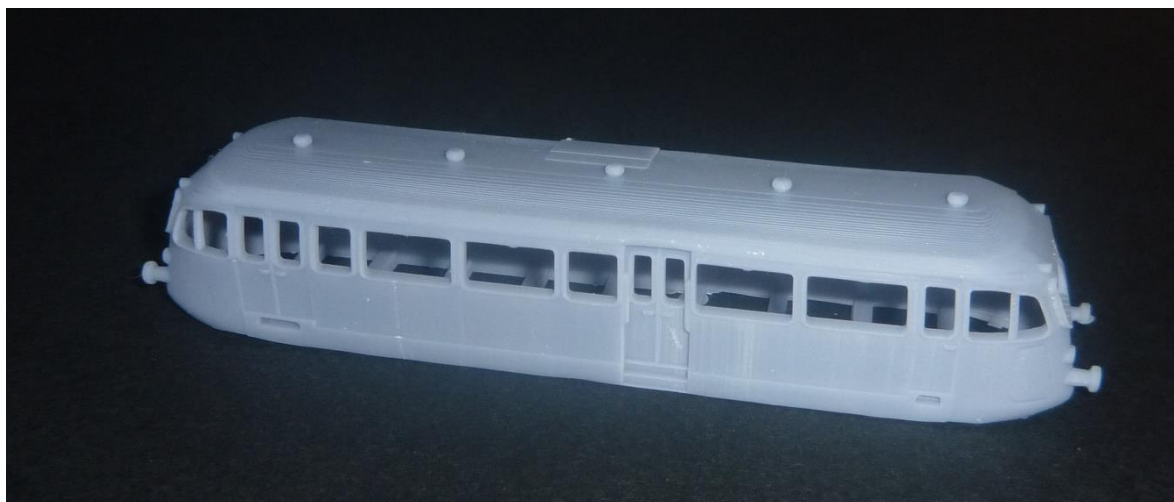

30 €

S.P.A.N

12 rue Alain-fournier

53000 Laval

0619443310 - stpoup1@gmail.com

N°Siret : 891 865 883 00013



Autorail BILLARD A75D



Autorail Billard type A-75-D n°901-903. c.f. de Mamers à Saint-Calais

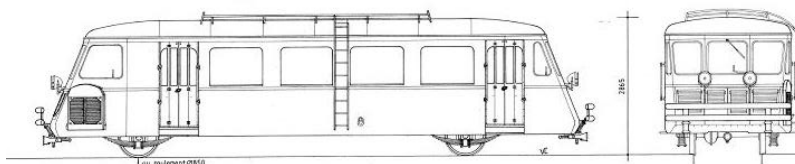

25 €



Autorail BILLARD A150D

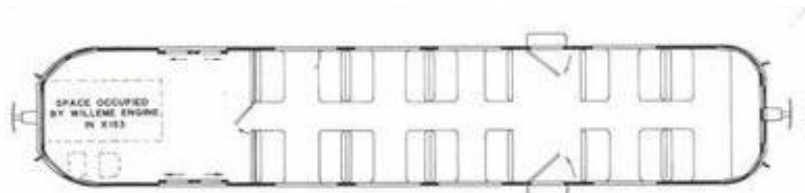

30 €

S.P.A.N

12 rue Alain-fourmier

53000 Laval

0619443310 - stpoup1@gmail.com

N°Siret : 891 865 883 00013



BB 1-80 (Biquette)

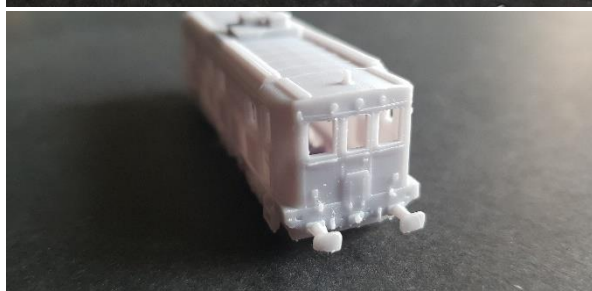

30

€Existe en 2 parties (caisse + flans)

S.P.A.N

12 rue Alain-fourmier

53000 Laval

0619443310 - stpoup1@gmail.com

N°Siret : 891 865 883 00013

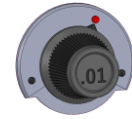

BB 400

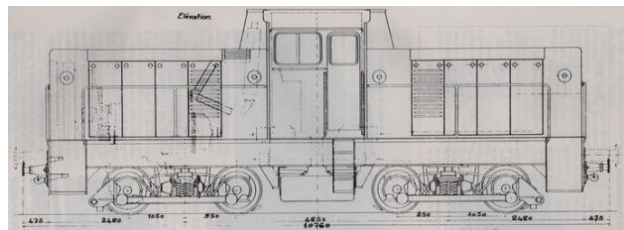
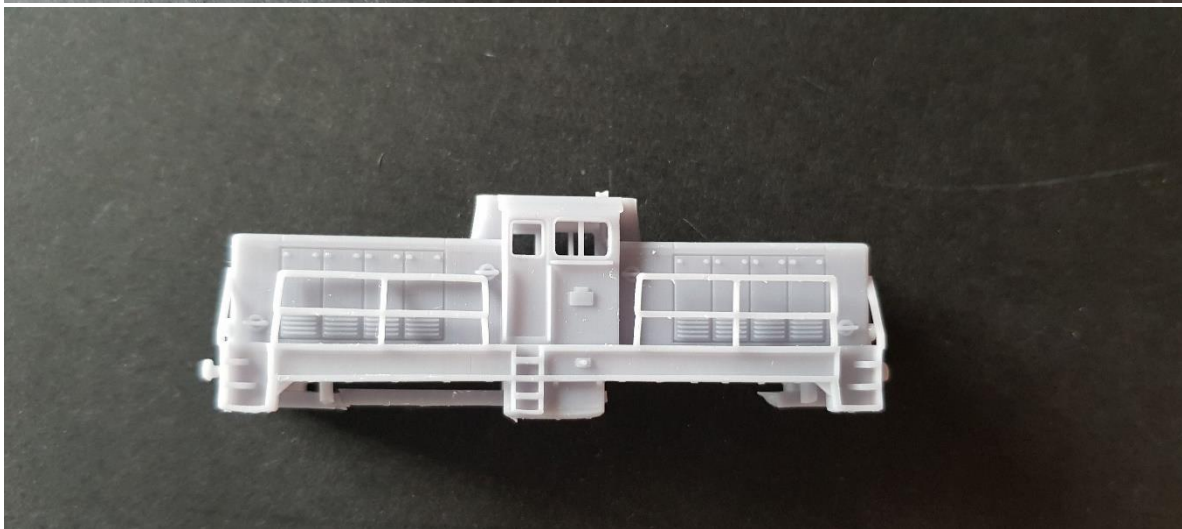

25 €

S.P.A.N

12 rue Alain-fourmier

53000 Laval

0619443310 - stpoup1@gmail.com

N°Siret : 891 865 883 00013



BB 8500

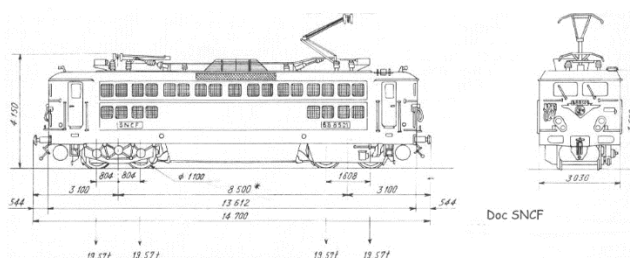
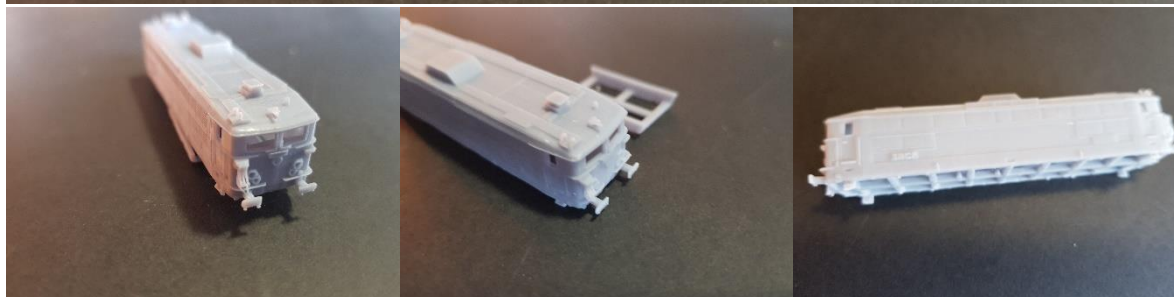

30 €

S.P.A.N

12 rue Alain-fourmier

53000 Laval

0619443310 - stpoup1@gmail.com

N°Siret : 891 865 883 00013



BB 9003

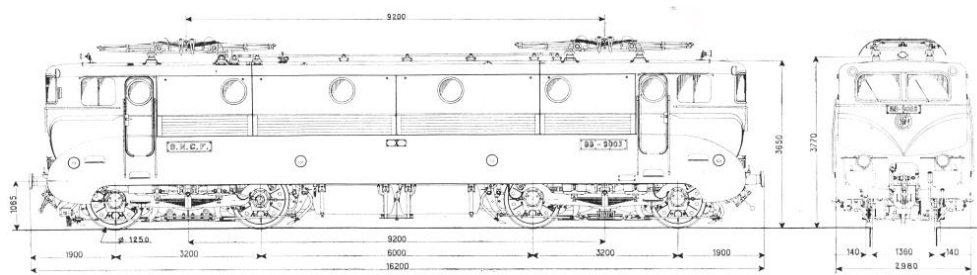
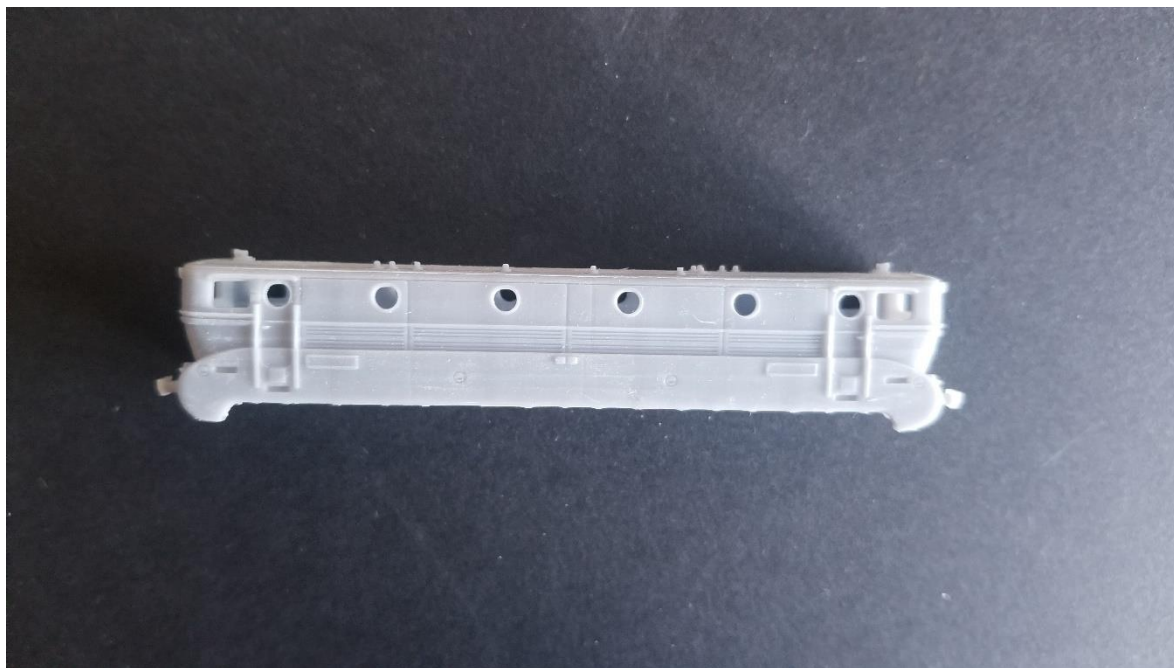

30 €

S.P.A.N

12 rue Alain-fournier

53000 Laval

0619443310 - stpoup1@gmail.com

N°Siret : 891 865 883 00013



BB 12000

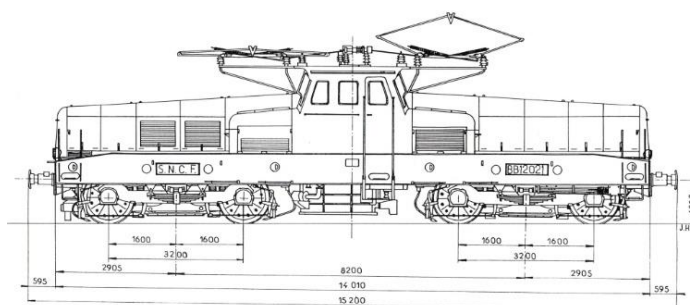

30 €

S.P.A.N

12 rue Alain-fournier

53000 Laval

0619443310 - stpoup1@gmail.com

N°Siret : 891 865 883 00013



BB 16500

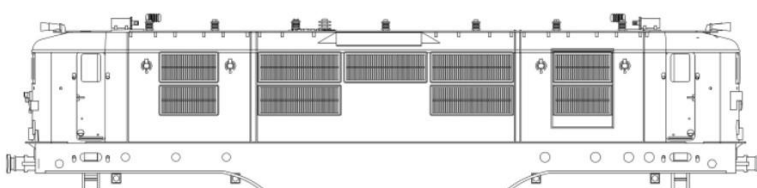
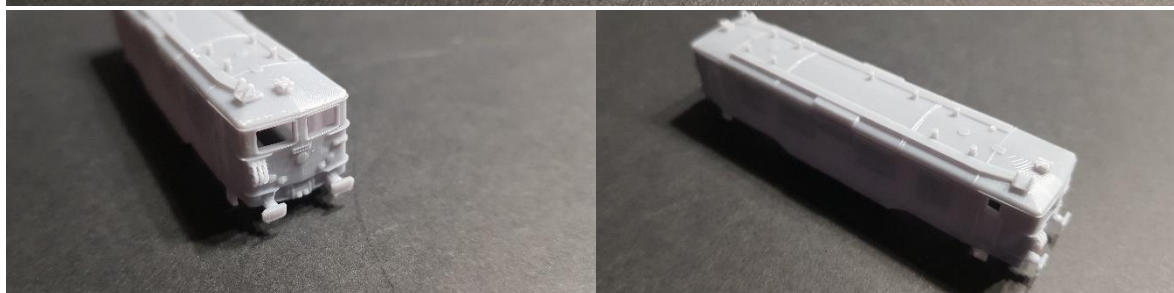
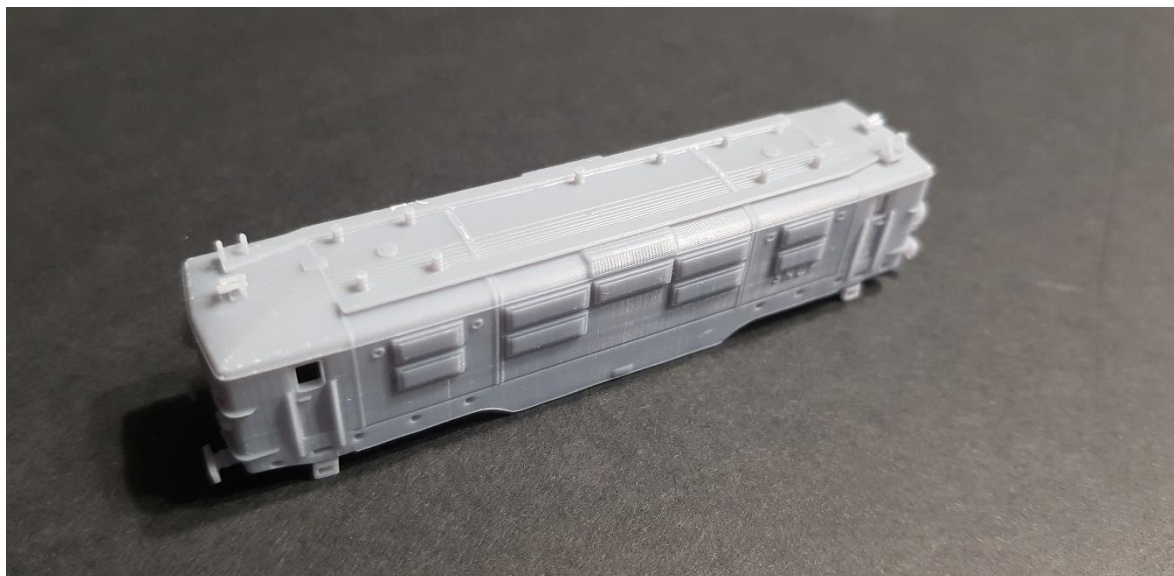

30 €

S.P.A.N

12 rue Alain-fourmier

53000 Laval

0619443310 - stpoup1@gmail.com

N°Siret : 891 865 883 00013



BB 36000

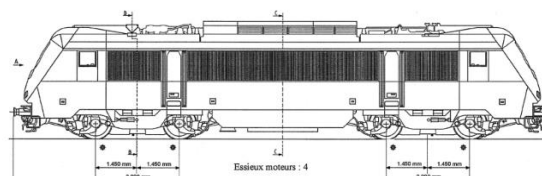

30 €

S.P.A.N

12 rue Alain-fourmier

53000 Laval

0619443310 - stpoup1@gmail.com

N°Siret : 891 865 883 00013



BB 66000

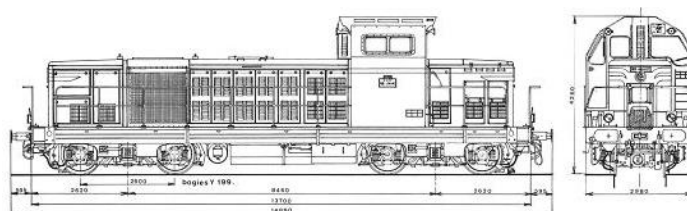
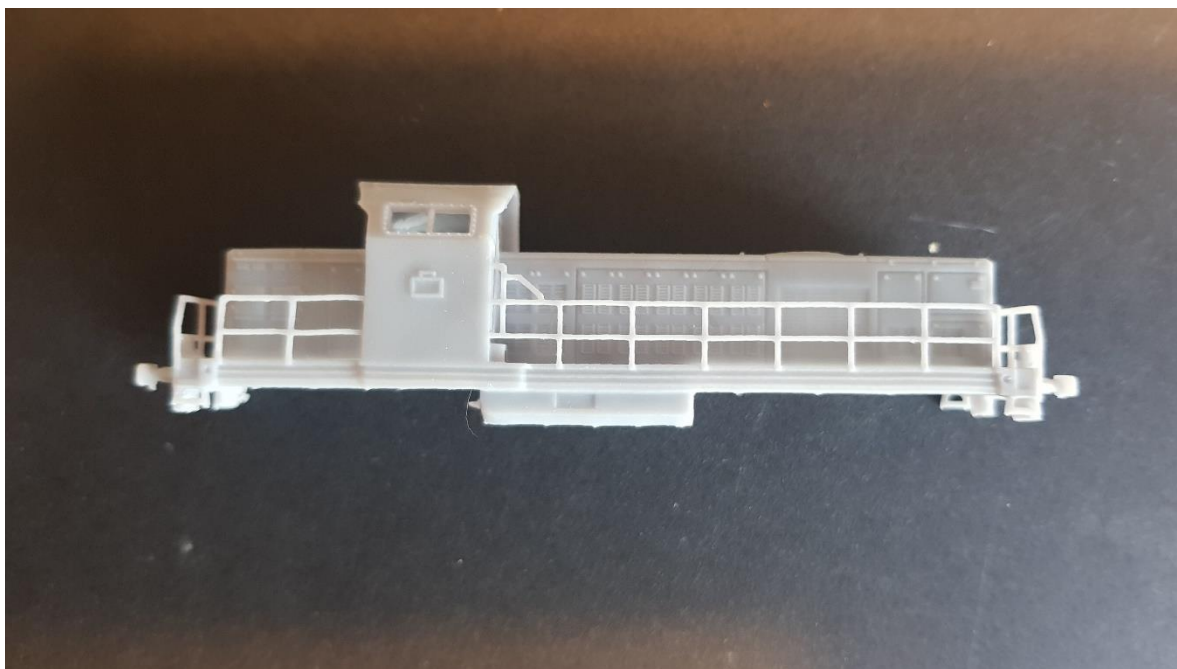

30 €

S.P.A.O.

12 rue Alain-fourmier

53000 Laval

0619443310 - stpoup1@gmail.com

N°Siret : 891 865 883 00013



BB 67000

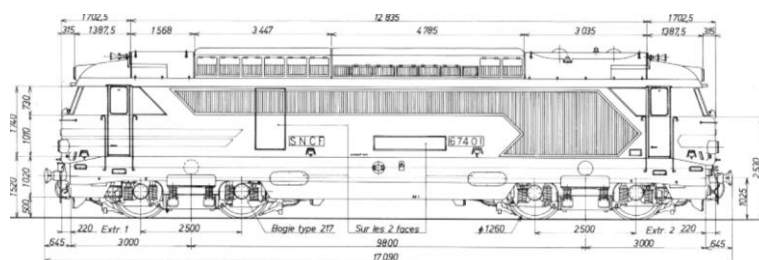
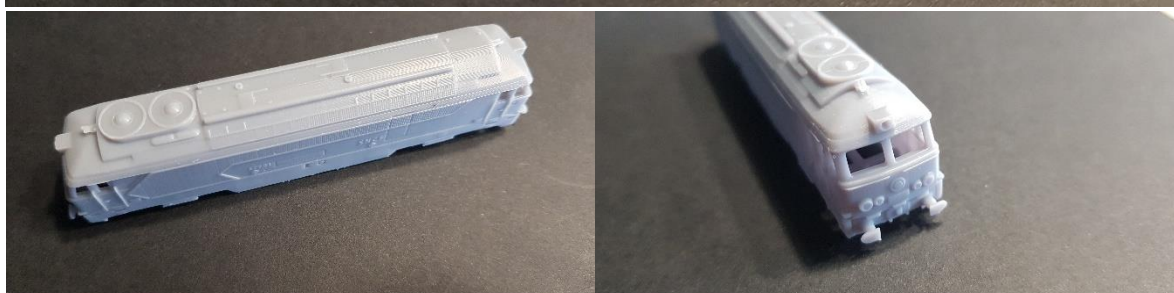

30 €

S.P.A.N

12 rue Alain-fournier

53000 Laval

0619443310 - stpoup1@gmail.com

N°Siret : 891 865 883 00013

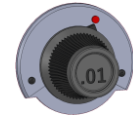

A1A A1A 62000

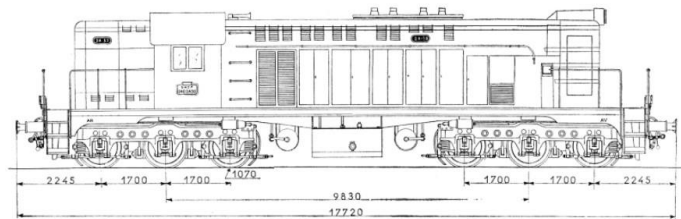
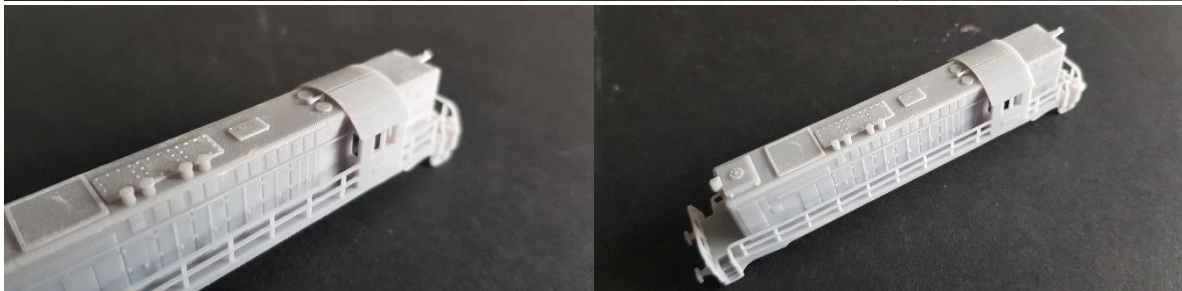

30 €

S.P.A.N

12 rue Alain-fourmier

53000 Laval

0619443310 - stpoup1@gmail.com

N°Siret : 891 865 883 00013



A1A A1A 68000

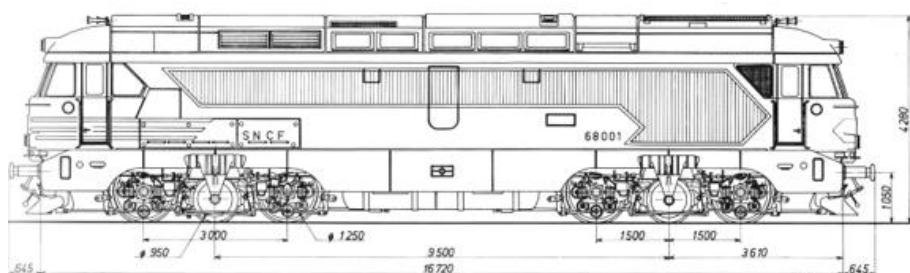
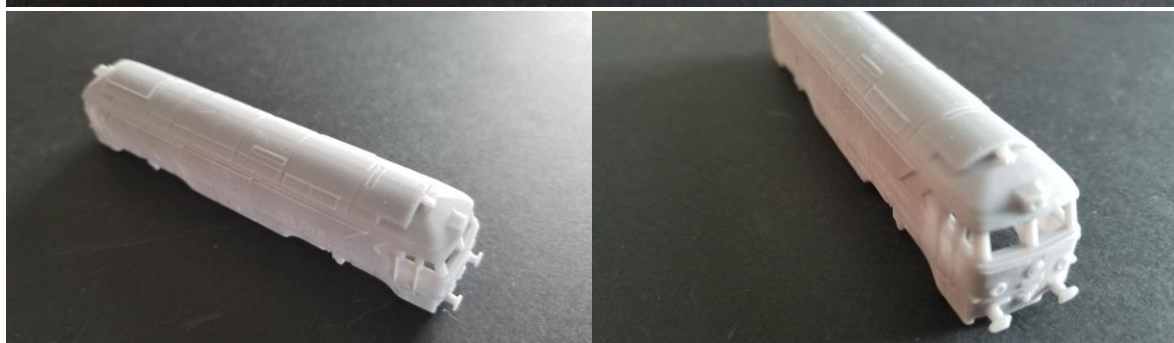

30 €

S.P.A.N

12 rue Alain-fourmier

53000 Laval

0619443310 - stpoup1@gmail.com

N°Siret : 891 865 883 00013



BB 75000

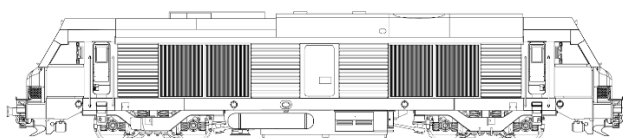

30 €

S.P.A.N

12 rue Alain-fourmier

53000 Laval

0619443310 - stpoup1@gmail.com

N°Siret : 891 865 883 00013

2D2

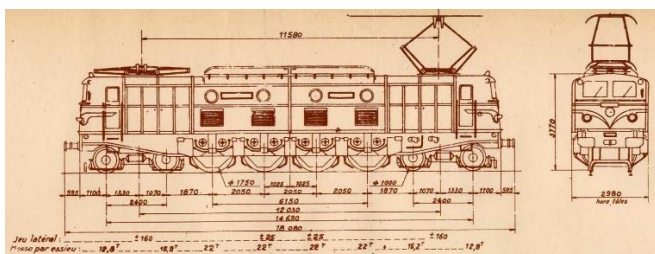
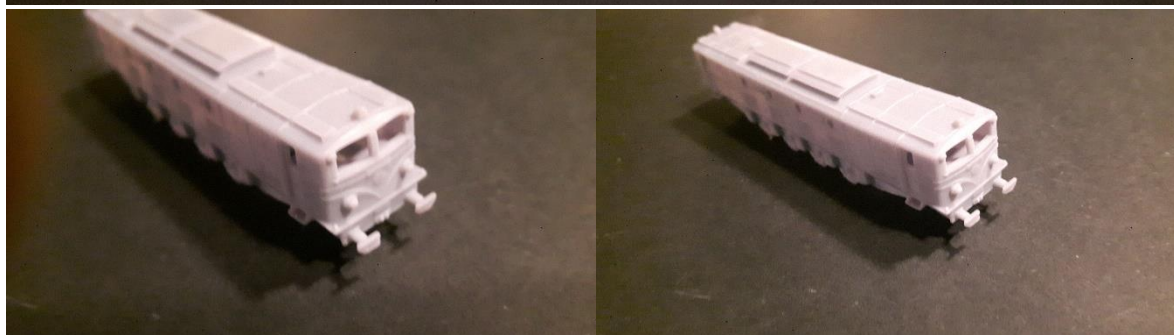
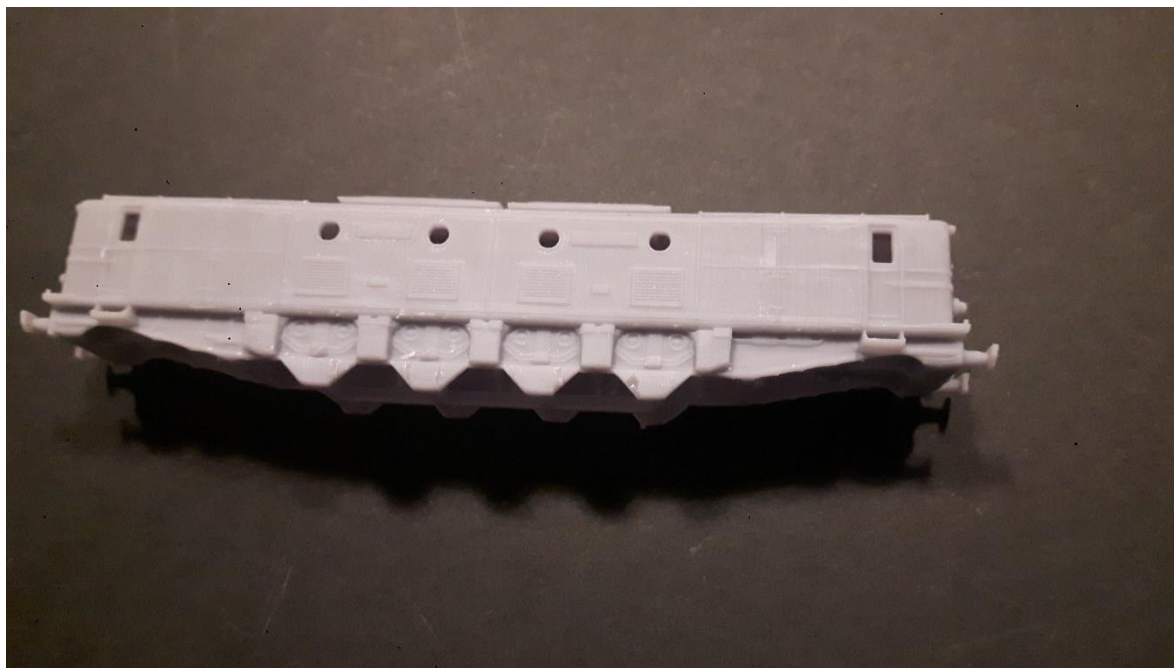

30 €

S.P.A.N

12 rue Alain-fournier

53000 Laval

0619443310 - stpoup1@gmail.com

N°Siret : 891 865 883 00013



2D2 – nez de cochon

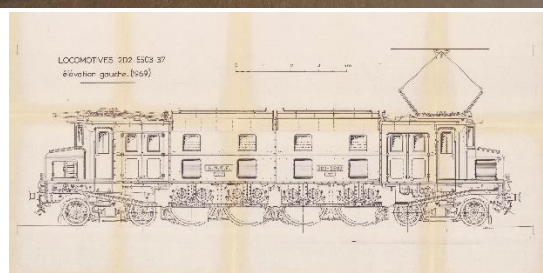

30 €

S.P.A.N

12 rue Alain-fourmier

53000 Laval

0619443310 - stpoup1@gmail.com

N°Siret : 891 865 883 00013



2D2 - WATERMAN

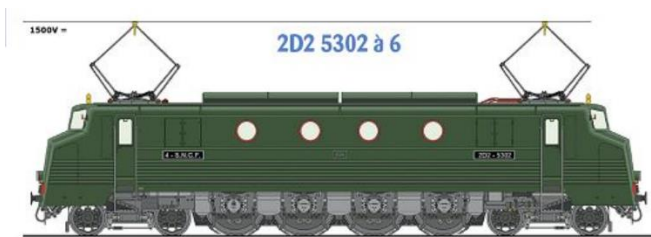

30 €

Picasso + remorque

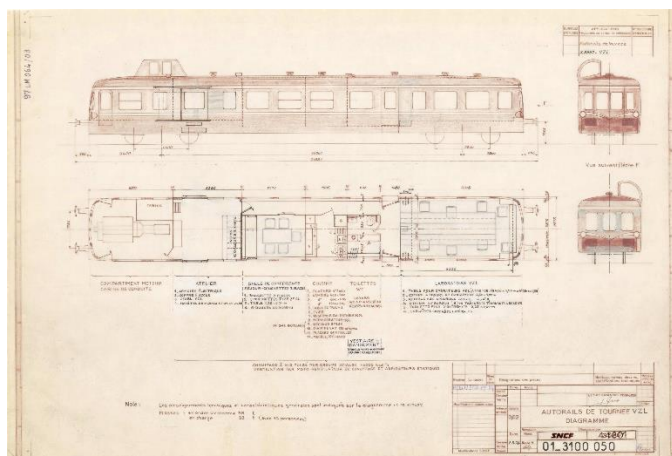
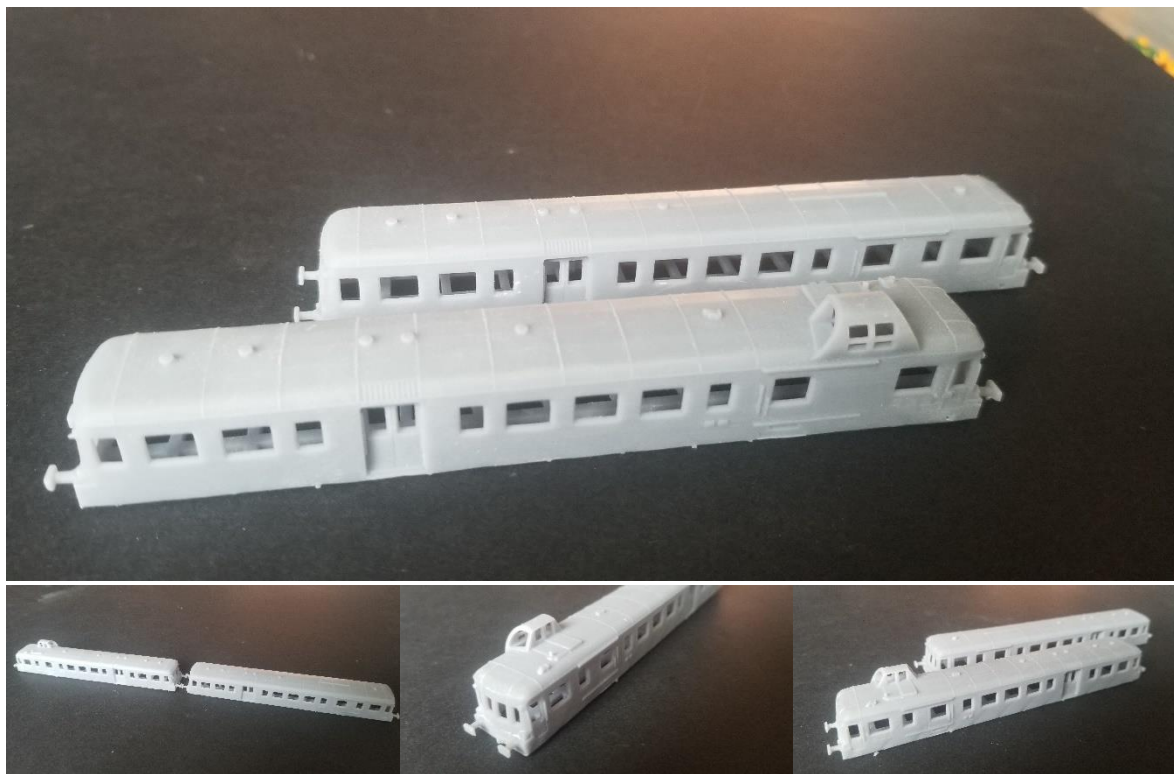

50 €

Possibilité de vente séparée (Picasso ou remorque (30€ pièce)).

S.P.A.N

12 rue Alain-fournier

53000 Laval

0619443310 - stpoup1@gmail.com

N°Siret : 891 865 883 00013



Locotracteur YMO2100

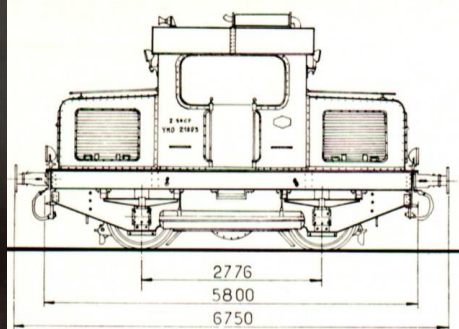
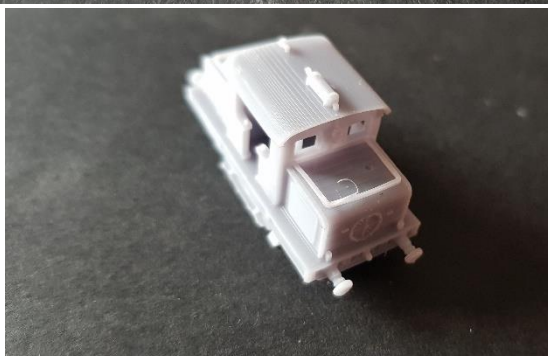
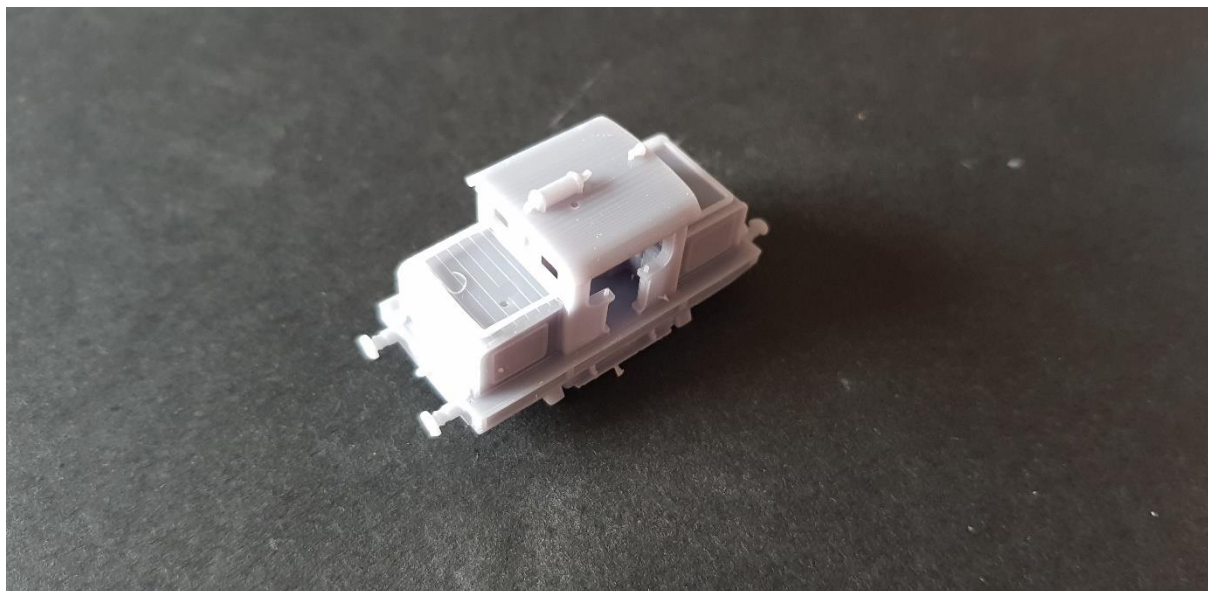

25 €

S.P.A.N

12 rue Alain-fournier

53000 Laval

0619443310 - stpoup1@gmail.com

N°Siret : 891 865 883 00013



Locotracteur BDR020

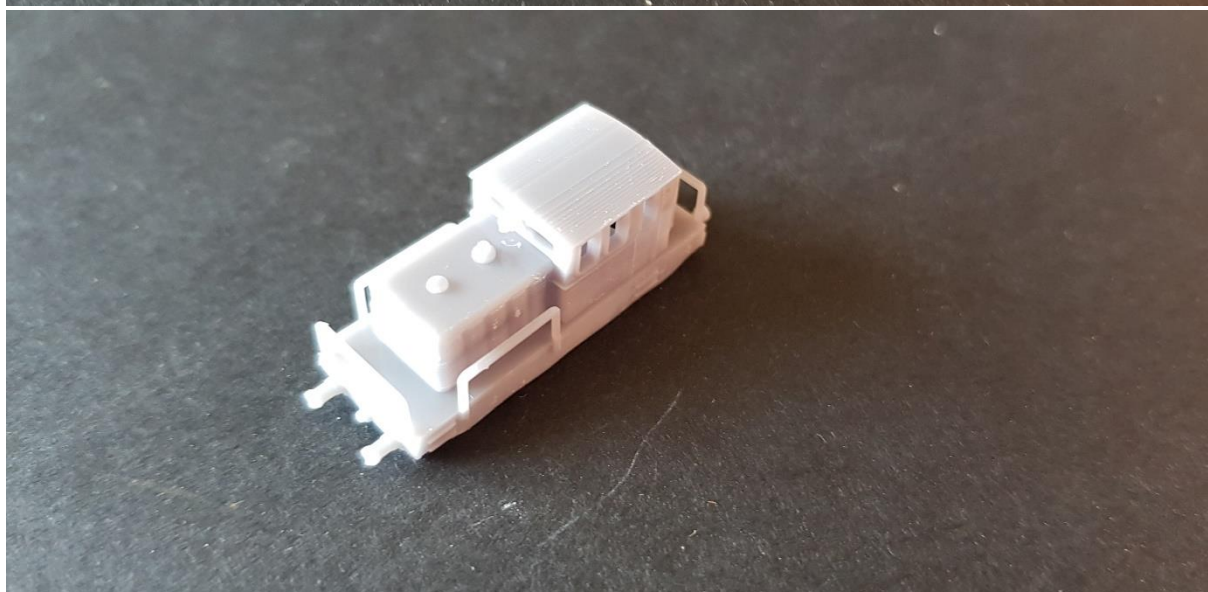
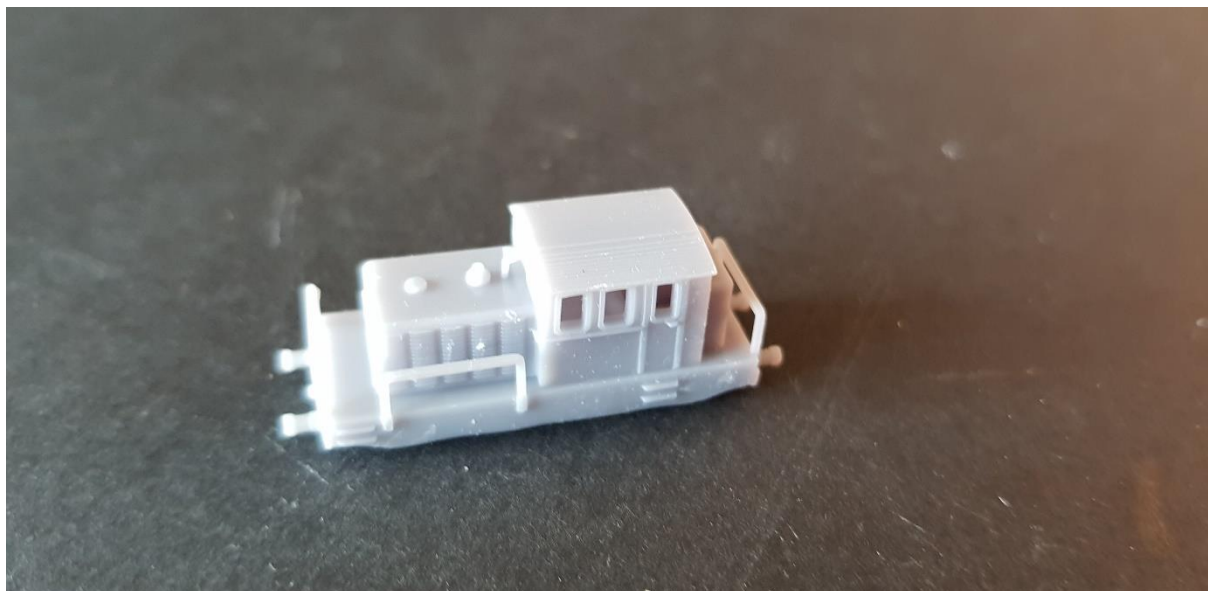

25 €

S.P.A.O.

12 rue Alain-fourmier

53000 Laval

0619443310 - stpoup1@gmail.com

N°Siret : 891 865 883 00013

Fourgon « Orient Express »

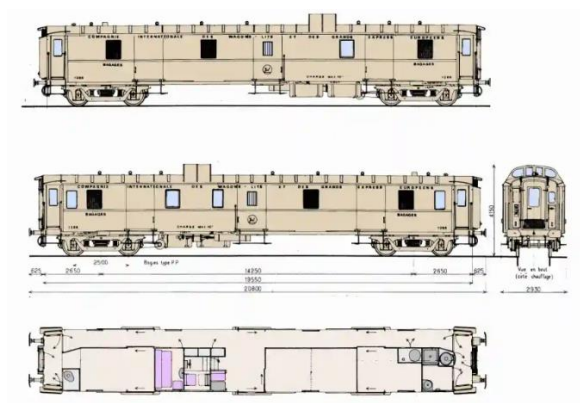
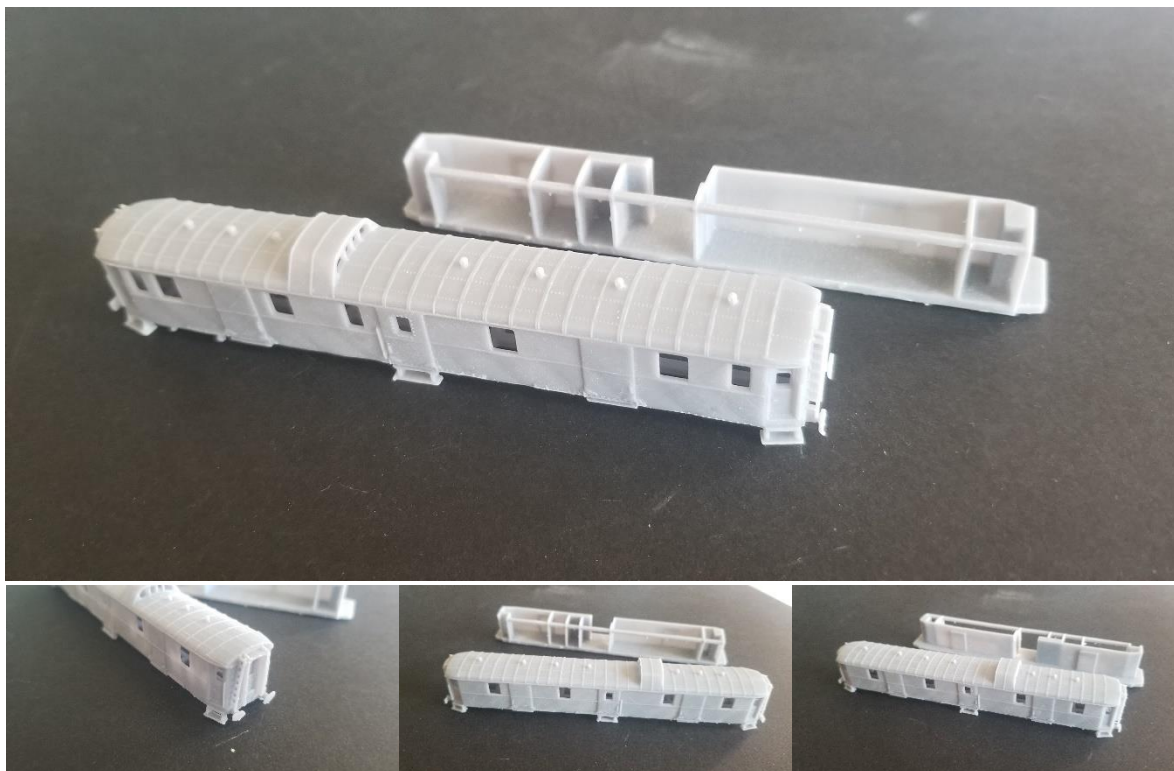

30 €

Wagon B6Q

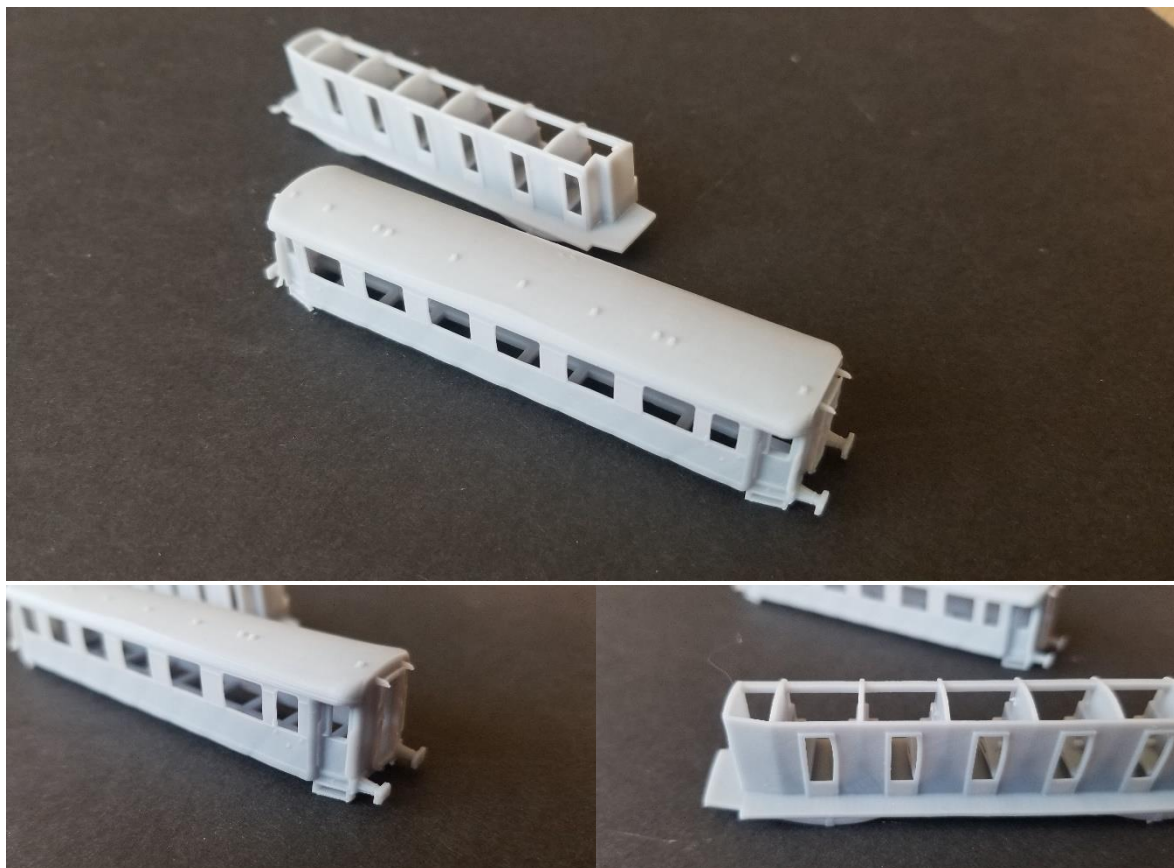

25 €



Wagon DD2

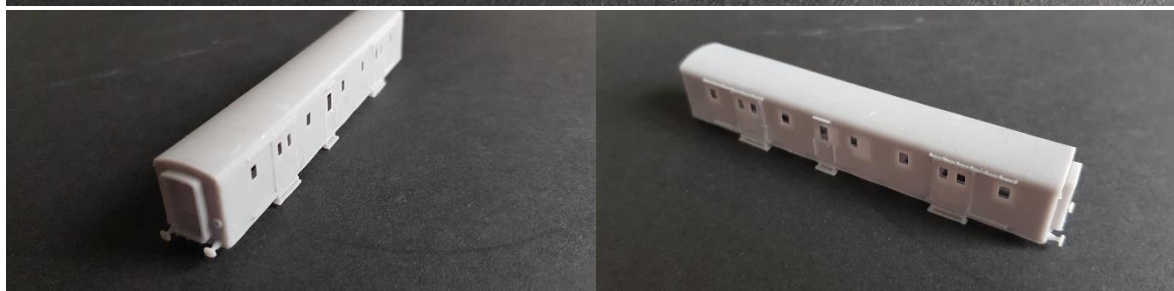
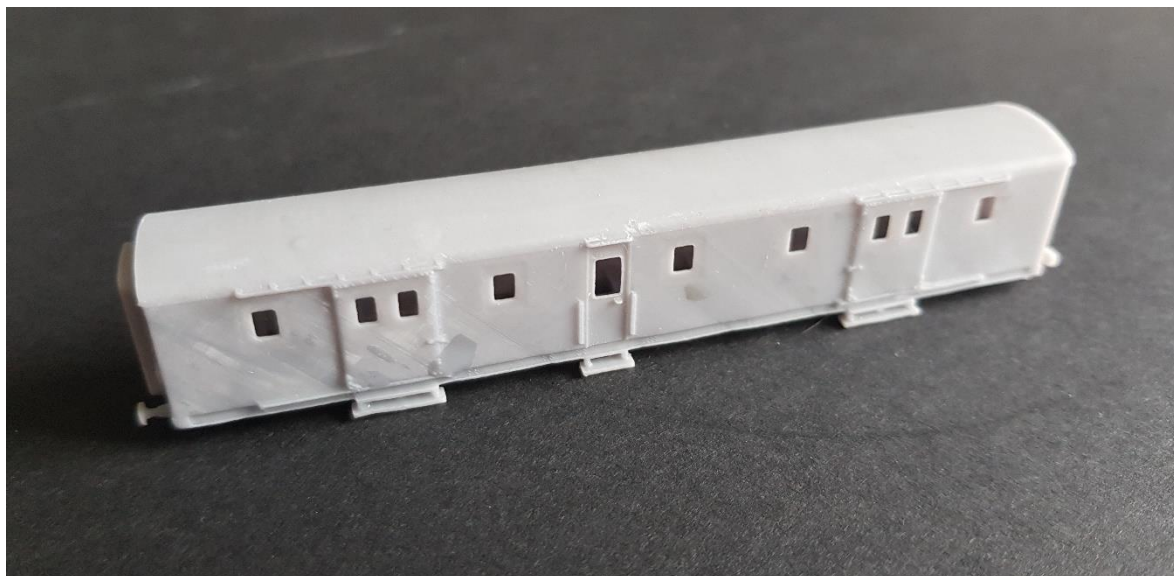

20 €

S.P.A.O.

12 rue Alain-fourmier

53000 Laval

0619443310 - stpoup1@gmail.com

N°Siret : 891 865 883 00013



Wagon OCEM à rivets apparents

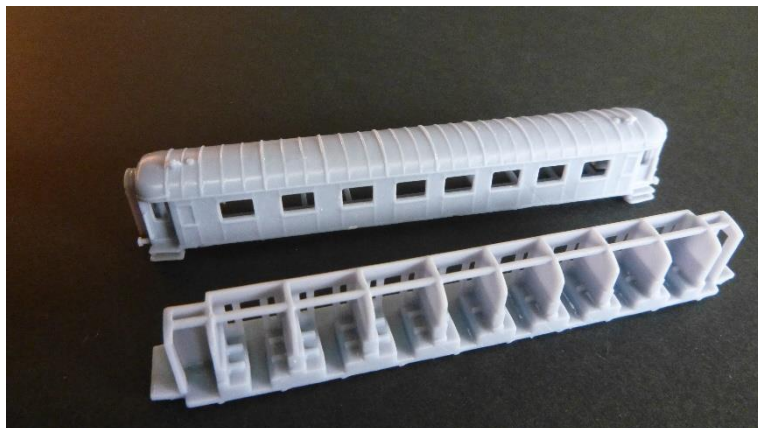

Wagon de 1^{ère} classe.

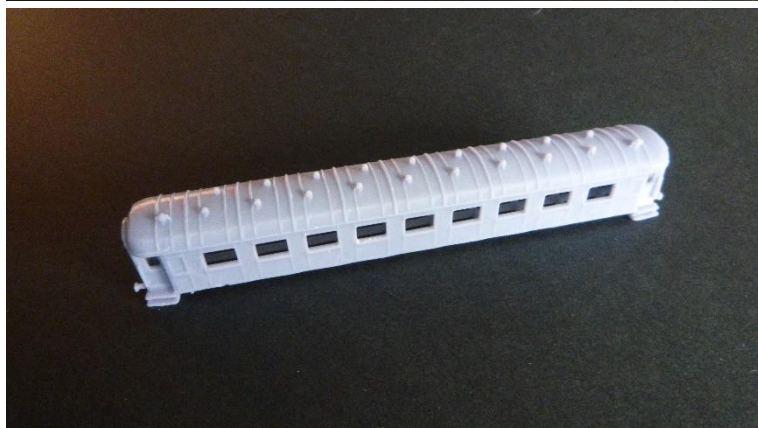

Wagon de 2nd classe.

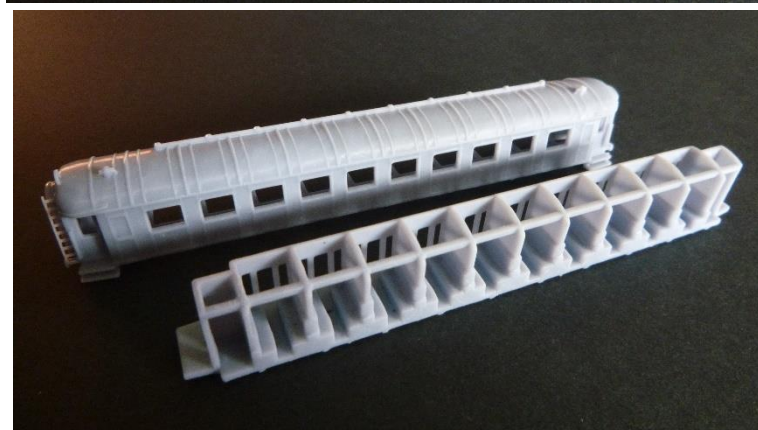

Wagon de 3^{ème} classe.

Existe en mixte 1^{ère} et 2nde classe, 3^{ème} classe-fourgon, fourgon (20€), 2nde saniterisable. Livré avec plancher (sauf fourgon)

S.P.A.N

12 rue Alain-fournier

53000 Laval

0619443310 - stpoup1@gmail.com

N°Siret : 891 865 883 00013



25€

Remorque Verney – XR9500

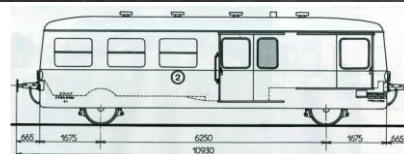

20 €

Remorque Somua

S.P.A.N

12 rue Alain-fournier

53000 Laval

0619443310 - stpoup1@gmail.com

N°Siret : 891 865 883 00013

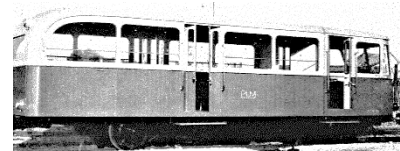
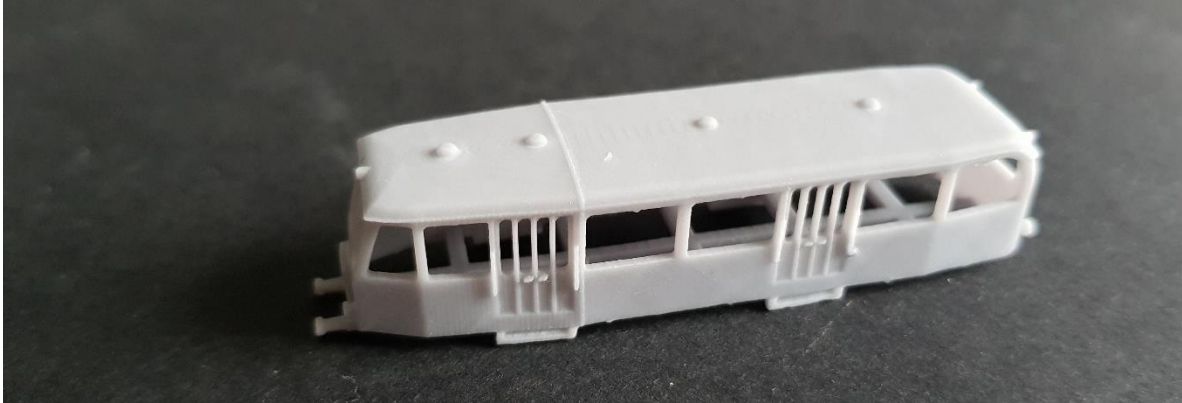
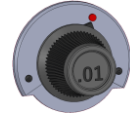

20 €

ELEMENTS DE DECORS

S.P.A.O.

12 rue Alain-fournier

53000 Laval

0619443310 - stpoup1@gmail.com

N°Siret : 891 865 883 00013



Modélisme au 160^{ème} en impression 3D

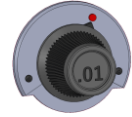

Gares et bâtiments ferroviaires

S.P.A.N

12 rue Alain-fourmier

53000 Laval

0619443310 - stpoup1@gmail.com

N°Siret : 891 865 883 00013



GARES DU P.O

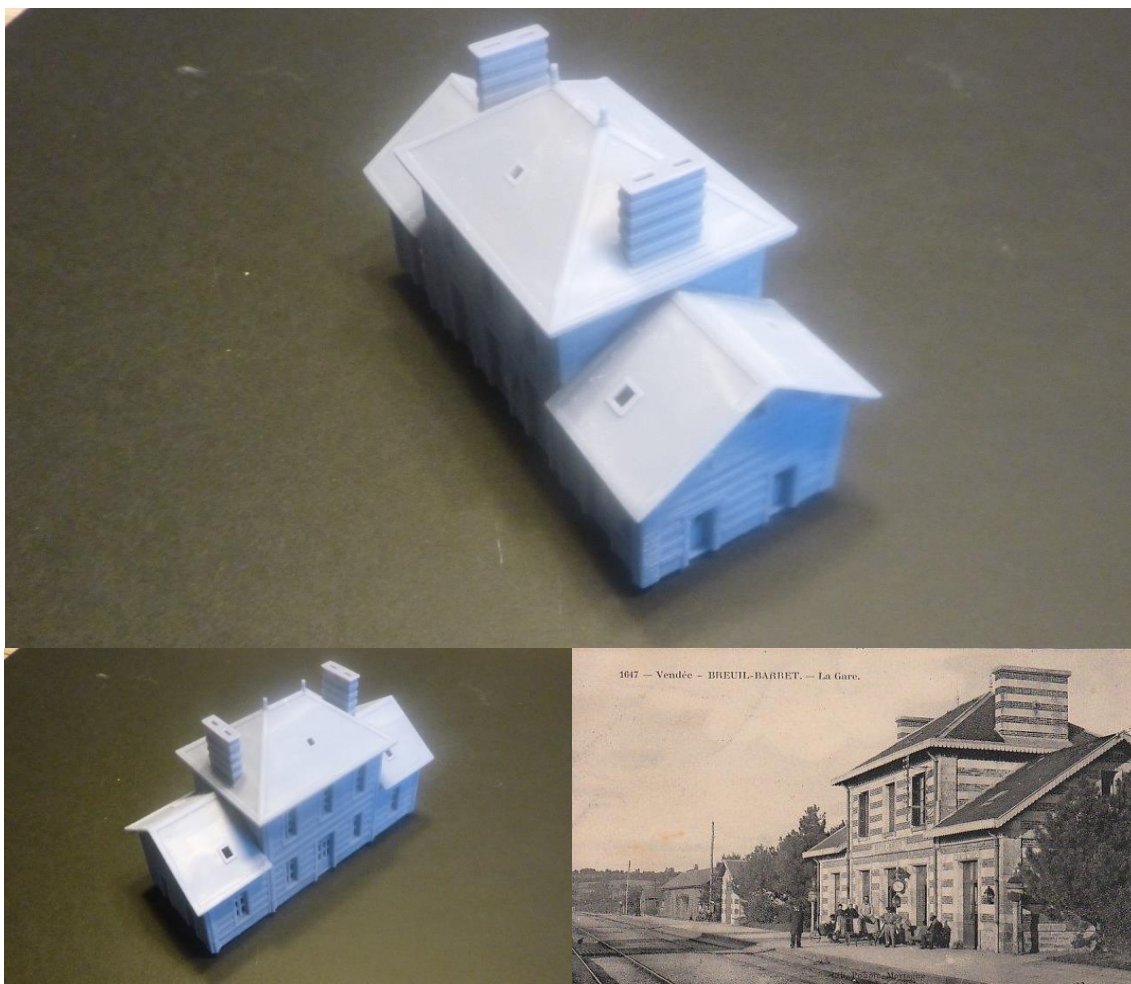

Gare PO – motif Pyjama – Modèle Breuil-Barret _____ 30 €

DIMENSIONS MAXIMALES : longueur = 120 mm, profondeur = 50 mm, hauteur = 75 mm

S.P.A.N

12 rue Alain-fournier

53000 Laval

0619443310 - stpoup1@gmail.com

N°Siret : 891 865 883 00013



Gare PO « Richelieu » **30 €**
DIMENSIONS MAXIMALES : longueur = 130 mm, profondeur = 45 mm, hauteur = 85 mm

S.P.A.O

12 rue Alain-fourmier

53000 Laval

0619443310 - stpoup1@gmail.com

N°Siret : 891 865 883 00013



Abri voyageurs type PO – Modèle Plouharnel-Carnac 10€
DIMENSIONS MAXIMALES : longueur = 77 mm, profondeur = 17 mm, hauteur = 28 mm

S.P.A.N

12 rue Alain-fourmier

53000 Laval

0619443310 - stpoup1@gmail.com

N°Siret : 891 865 883 00013

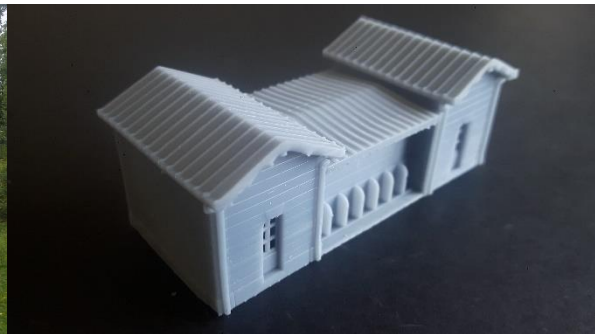
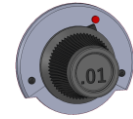

Abri voyageurs type PO – Modèle Coulonges sur l'Autize _____ 12 €

DIMENSIONS MAXIMALES : longueur = 75 mm, profondeur = 30 mm, hauteur = 29 mm



Abri voyageurs type PO – Modèle Saint Laurs _____ **10 €**
DIMENSIONS MAXIMALES : longueur = 58 mm, profondeur = 25 mm, hauteur = 28 mm

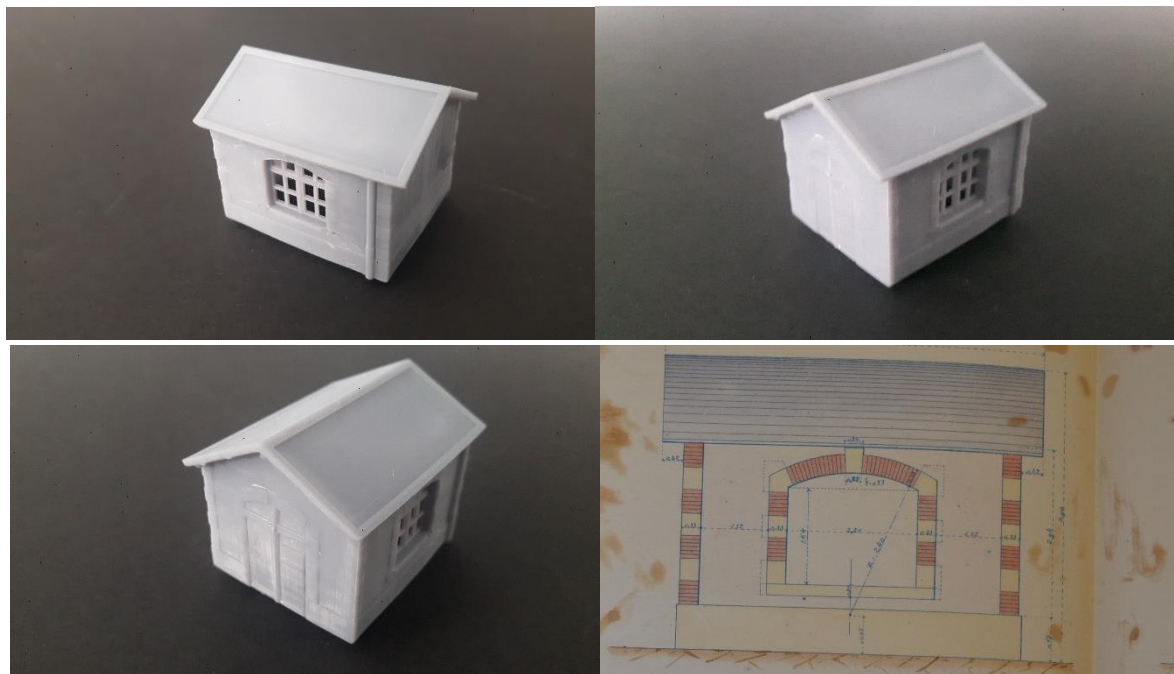

Bâtiment des bouillottes – Gare Breuil-Barret _____ 8 €

DIMENSIONS MAXIMALES : longueur = 36 mm, profondeur = 32 mm, hauteur = 30 mm



Les toilettes – Gare Vouvant-Cezais _____ 8 €

DIMENSIONS MAXIMALES : longueur = 36 mm, profondeur = 30 mm, hauteur = 23 mm

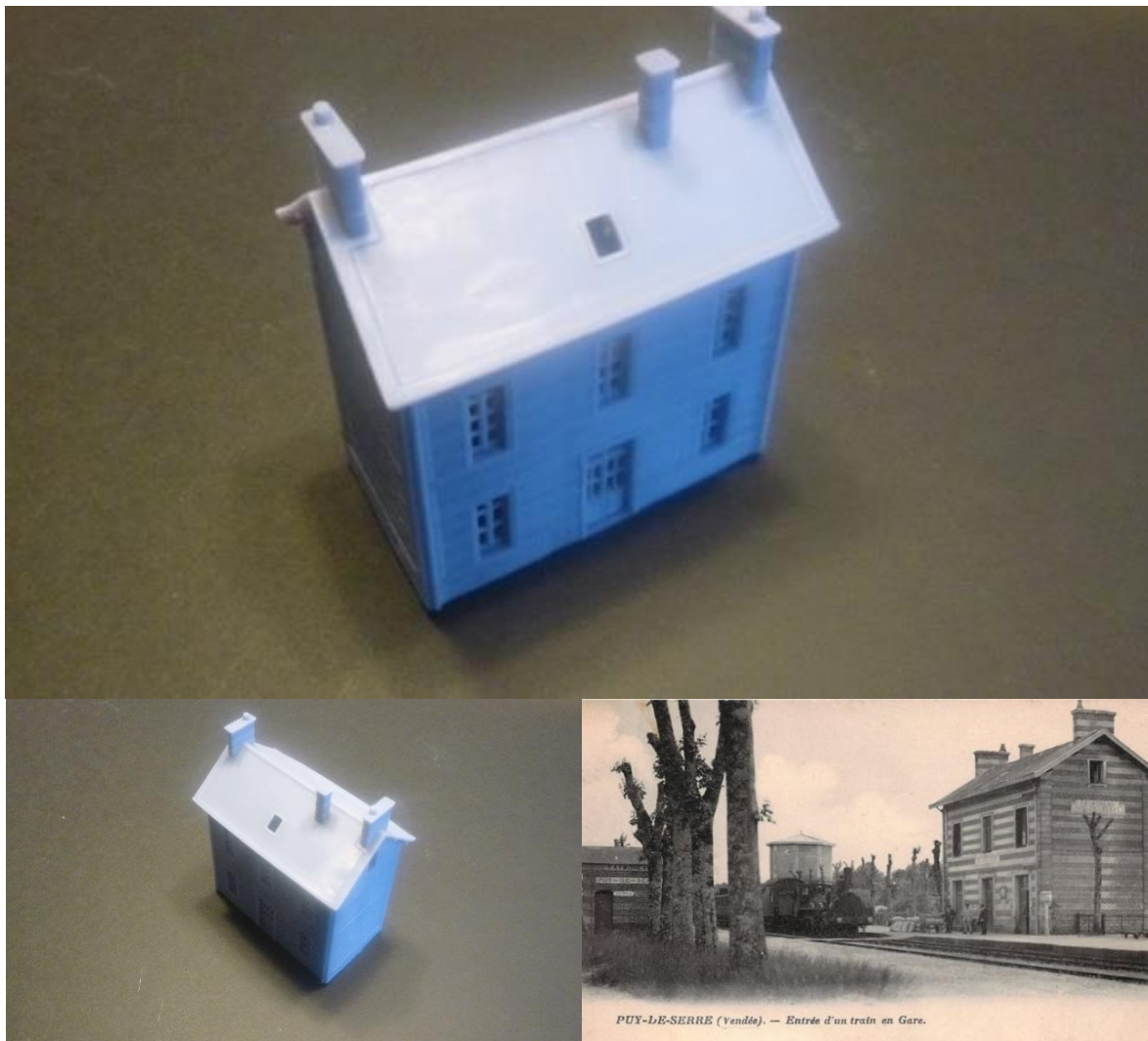

Gare PO – motif Pyjama – Modèle Puy-de-Serre _____ 25 €

DIMENSIONS MAXIMALES : longueur = 75 mm, profondeur = 42 mm, hauteur = 84 mm

S.P.A.N

12 rue Alain-fourmier

53000 Laval

0619443310 - stpoup1@gmail.com

N°Siret : 891 865 883 00013

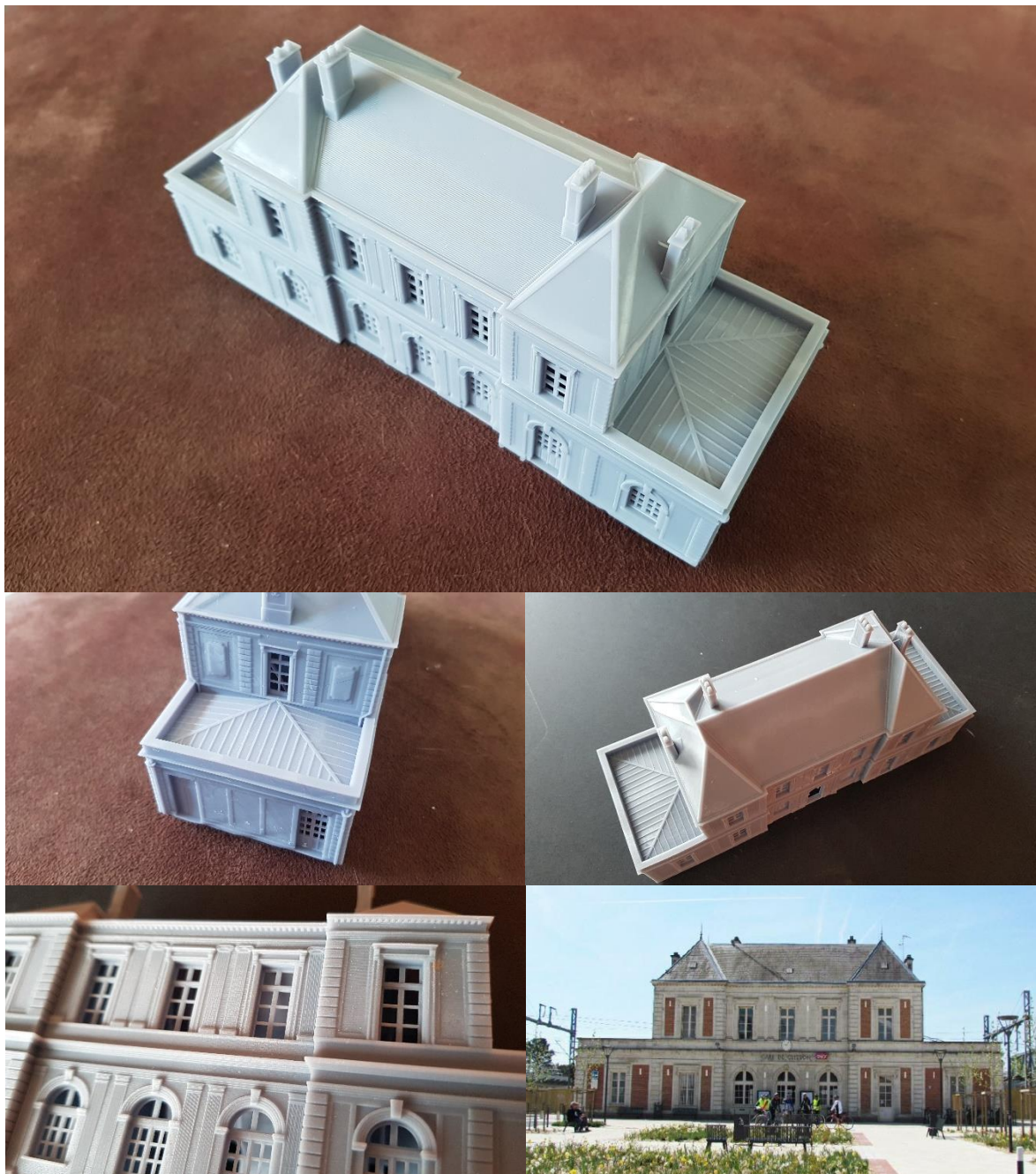

Gare de Clisson _____ 80 €

DIMENSIONS MAXIMALES : longueur = 187mm, profondeur = 65mm, hauteur = 95 mm

S.P.A.N

12 rue Alain-fourmier

53000 Laval

0619443310 - stpoup1@gmail.com

N°Siret : 891 865 883 00013



GARES « ETAT », « Charentes », Ouest

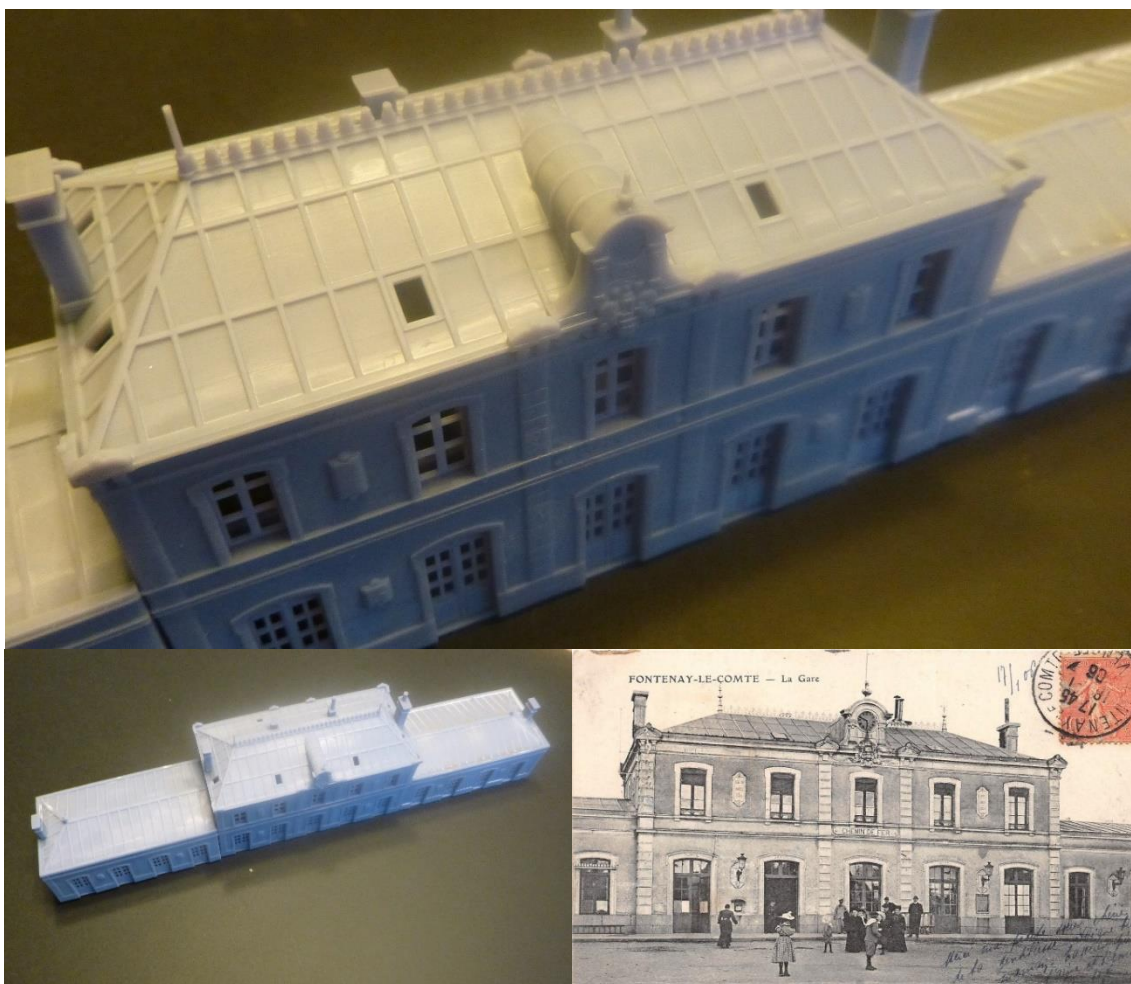

Gare Etat « Fontenay-le-Comte » (3 éléments à assembler) _____ 80 €

DIMENSIONS MAXIMALES : longueur = 430 mm, profondeur = 57 mm, hauteur = 84 mm

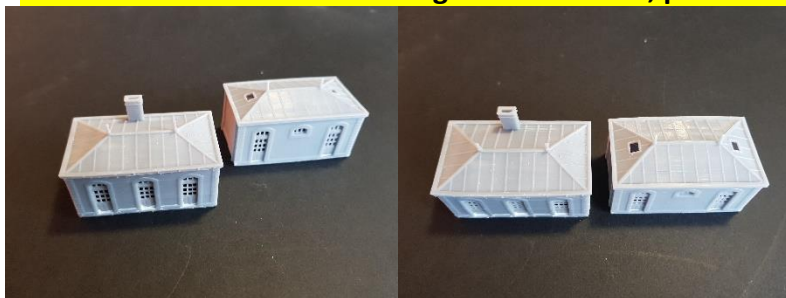

Annexes gare (les 2 - 15€)

S.P.A.N

12 rue Alain-fournier

53000 Laval

0619443310 - stpoup1@gmail.com

N°Siret : 891 865 883 00013

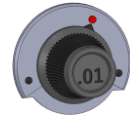

Gare Compagnie des Charentes « VELLUIRE »

40 €

DIMENSIONS MAXIMALES : longueur = 175 mm, profondeur = 67 mm, hauteur = 68 mm



Gare Compagnie des Charentes simple « Ile d'Elle » 30 €



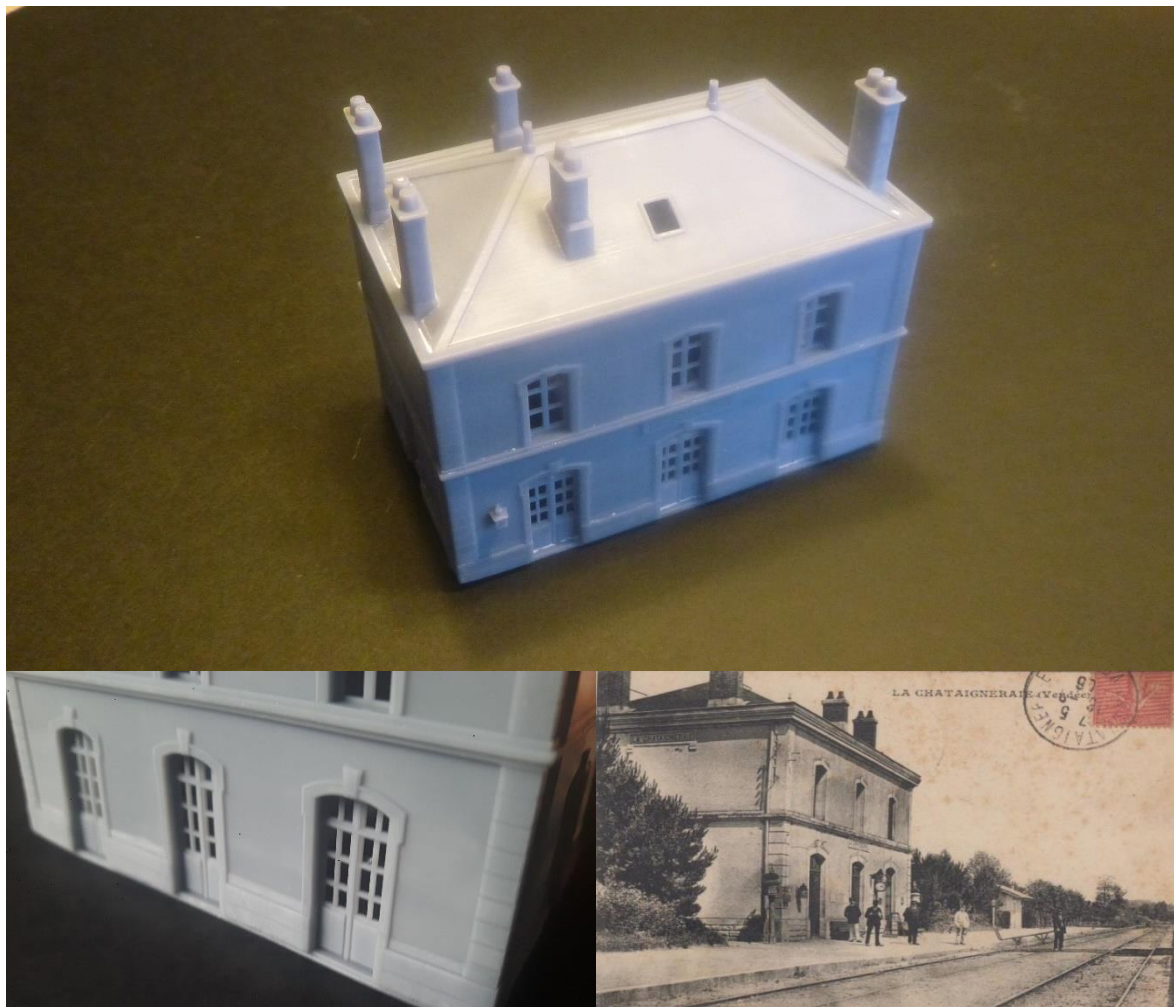

Gare Etat « La Chataigneraie » _____ 25 €

DIMENSIONS MAXIMALES : longueur = 90 mm, profondeur = 57 mm, hauteur = 78 mm

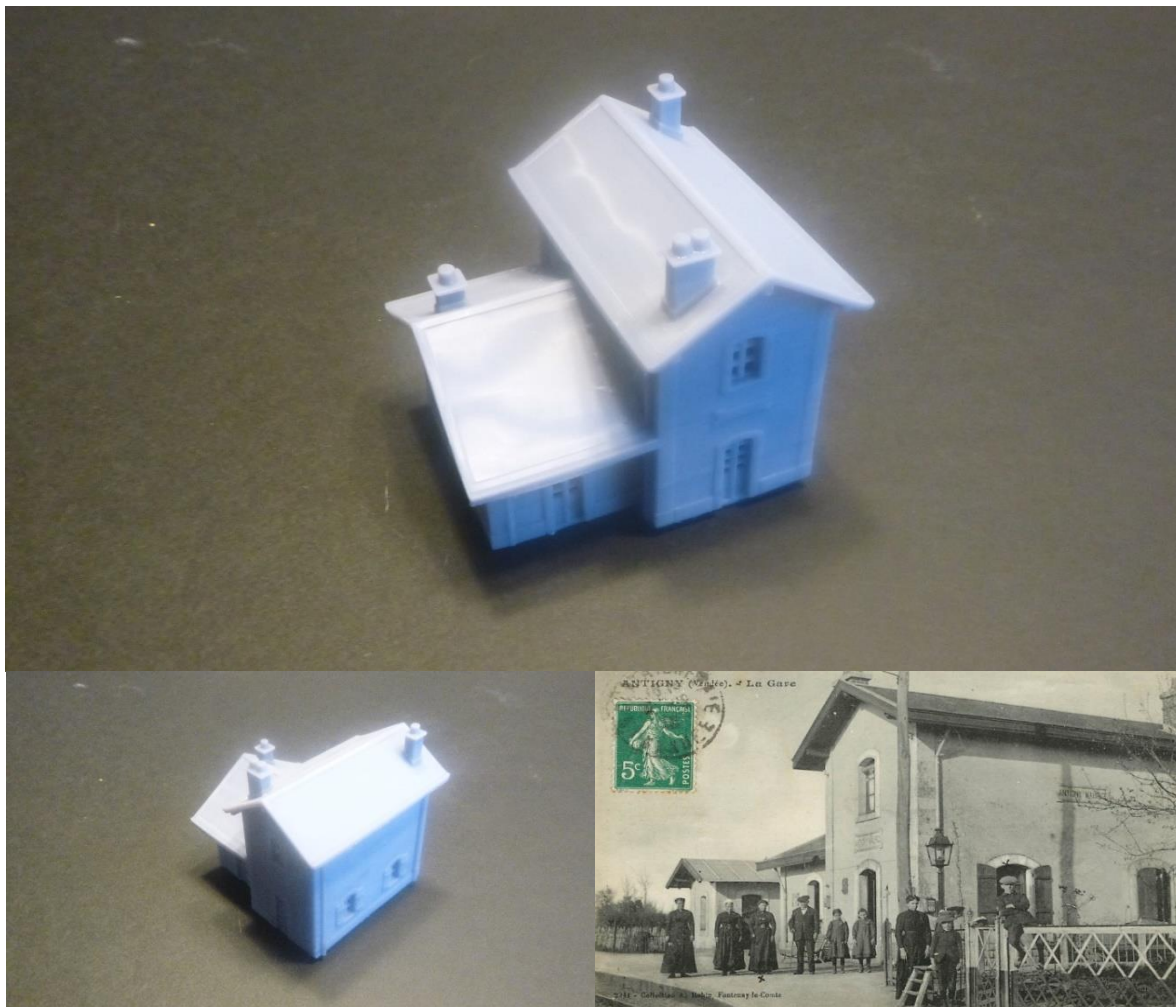

Halte voyageurs « Antigny - St Maurice » _____ 20 €

DIMENSIONS MAXIMALES : longueur = 60 mm, profondeur = 54 mm, hauteur = 59 mm

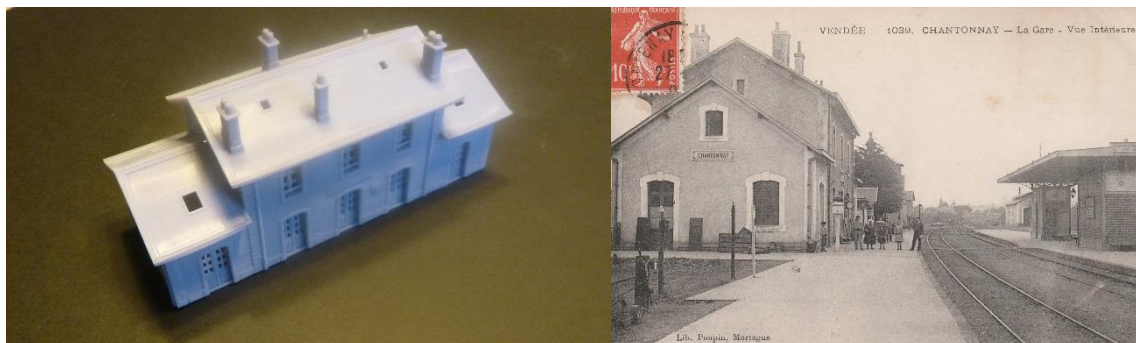

Gare Etat « Vouvant-Cezais » (+ 2 ailes) _____ 30 €

DIMENSIONS MAXIMALES : longueur = mm, profondeur = mm, hauteur = mm

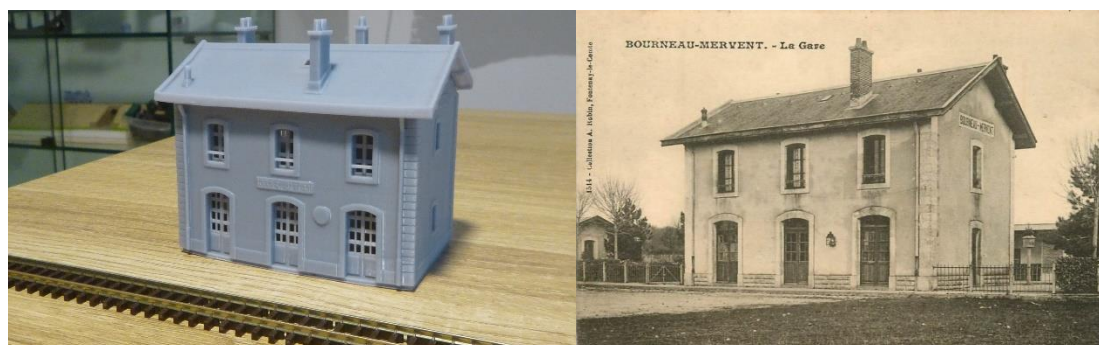

Gare Etat « Bourneau » _____ 25 €

DIMENSIONS MAXIMALES : longueur = 82 mm, profondeur = 49 mm, hauteur = 70 mm

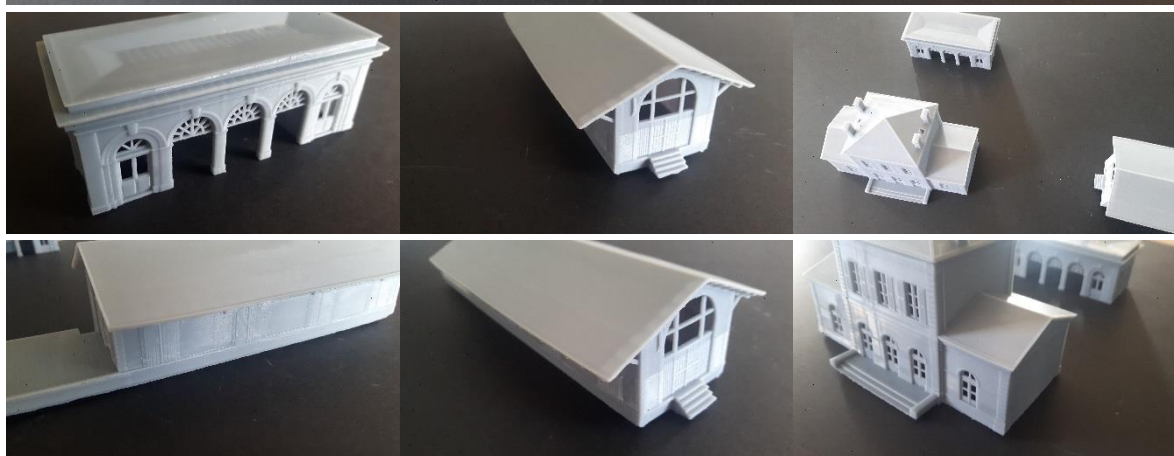
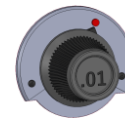

Gare « La Méritré » _____	30 €
L'abri voyageurs (2 versions) _____	20 €
La halle marchandises _____	25 €

S.P.A.N

12 rue Alain-fourmier

53000 Laval

0619443310 - stpoup1@gmail.com

N°Siret : 891 865 883 00013

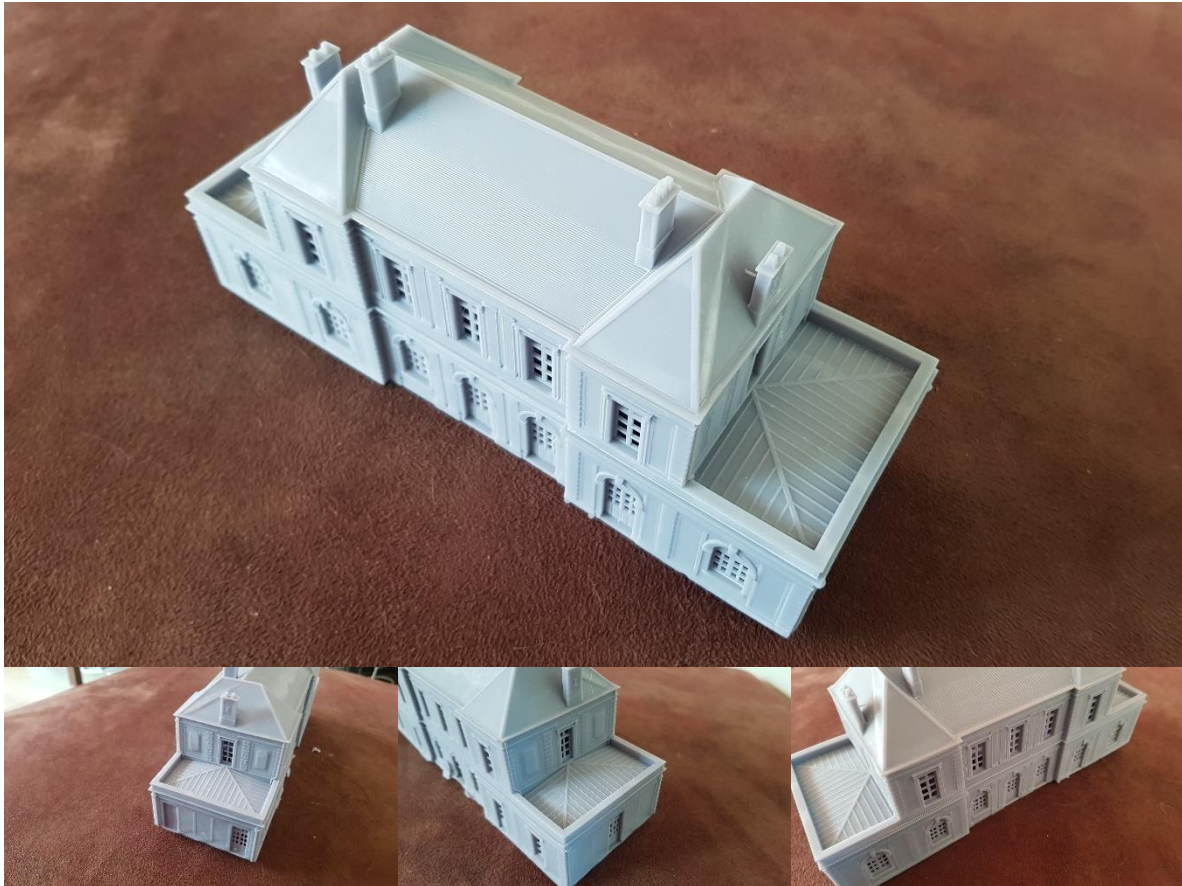
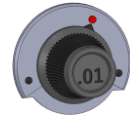

Gare de Clisson _____ (janvier 2023)

DIMENSIONS MAXIMALES : longueur = 175 mm, profondeur = 65 mm, hauteur = 87 mm

S.P.A.N

12 rue Alain-fournier

53000 Laval

0619443310 - stpoup1@gmail.com

N°Siret : 891 865 883 00013



La maison du garde-barrières avec apprentis (Pissotte) _____ 12 €

DIMENSIONS MAXIMALES : longueur = 62 mm, profondeur = 32 mm, hauteur = 44 mm



La maison du garde-barrières simple (Breuil-Barret) _____ 10 €

DIMENSIONS MAXIMALES : longueur = 48 mm, profondeur = 32 mm, hauteur = 44 mm

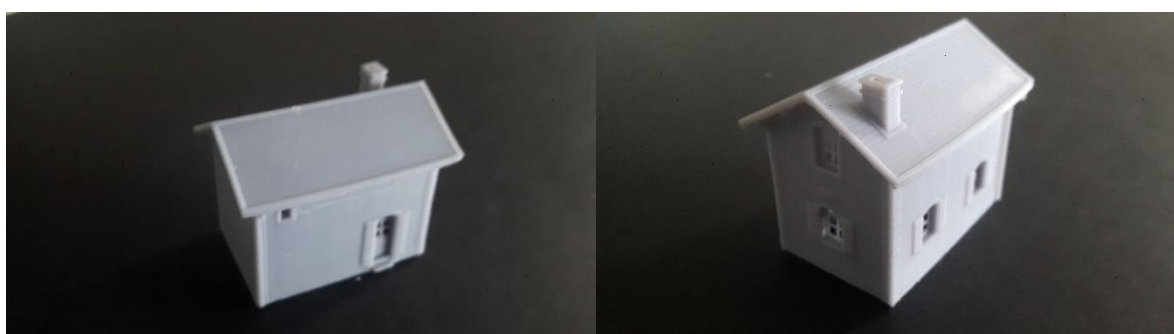

La maison du garde-barrières simple (Fontenay-le-Comte) _____ 10 €

DIMENSIONS MAXIMALES : longueur = 48 mm, profondeur = 32 mm, hauteur = 44 mm



L'abri marchandises simple type PO 15 €
DIMENSIONS MAXIMALES : longueur = 63mm, profondeur = 51mm, hauteur = 52mm



Puy-de-Serre (85)



L'abri marchandises double type PO _____ 25 €

DIMENSIONS MAXIMALES : longueur = 63mm, profondeur = 91mm, hauteur = 52mm

Saint Laurs (79)



S.P.A.N

12 rue Alain-fourmier

53000 Laval

0619443310 - stpoup1@gmail.com

N°Siret : 891 865 883 00013

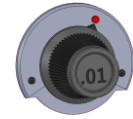

Le château d'eau type PO _____ 25 €

DIMENSIONS MAXIMALES : longueur = 44mm, profondeur = 44mm, hauteur = 74mm

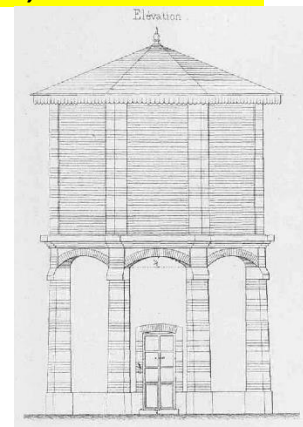

S.P.A.N

12 rue Alain-fournier

53000 Laval

0619443310 - stpoup1@gmail.com

N°Siret : 891 865 883 00013



Le château d'eau type PLM _____ 25 €
DIMENSIONS MAXIMALES : longueur = 37mm, profondeur = 37mm, hauteur = 78mm

S.P.A.N

12 rue Alain-fourrier

53000 Laval

0619443310 - stpoup1@gmail.com

N°Siret : 891 865 883 00013



Modélisme au 160^{ème} en impression 3D



Le château d'eau « Etat » gare de Vouvant – Cezais + station _____ 25 €

S.P.A.N

12 rue Alain-fourmier

53000 Laval

0619443310 - stpoup1@gmail.com

N°Siret : 891 865 883 00013

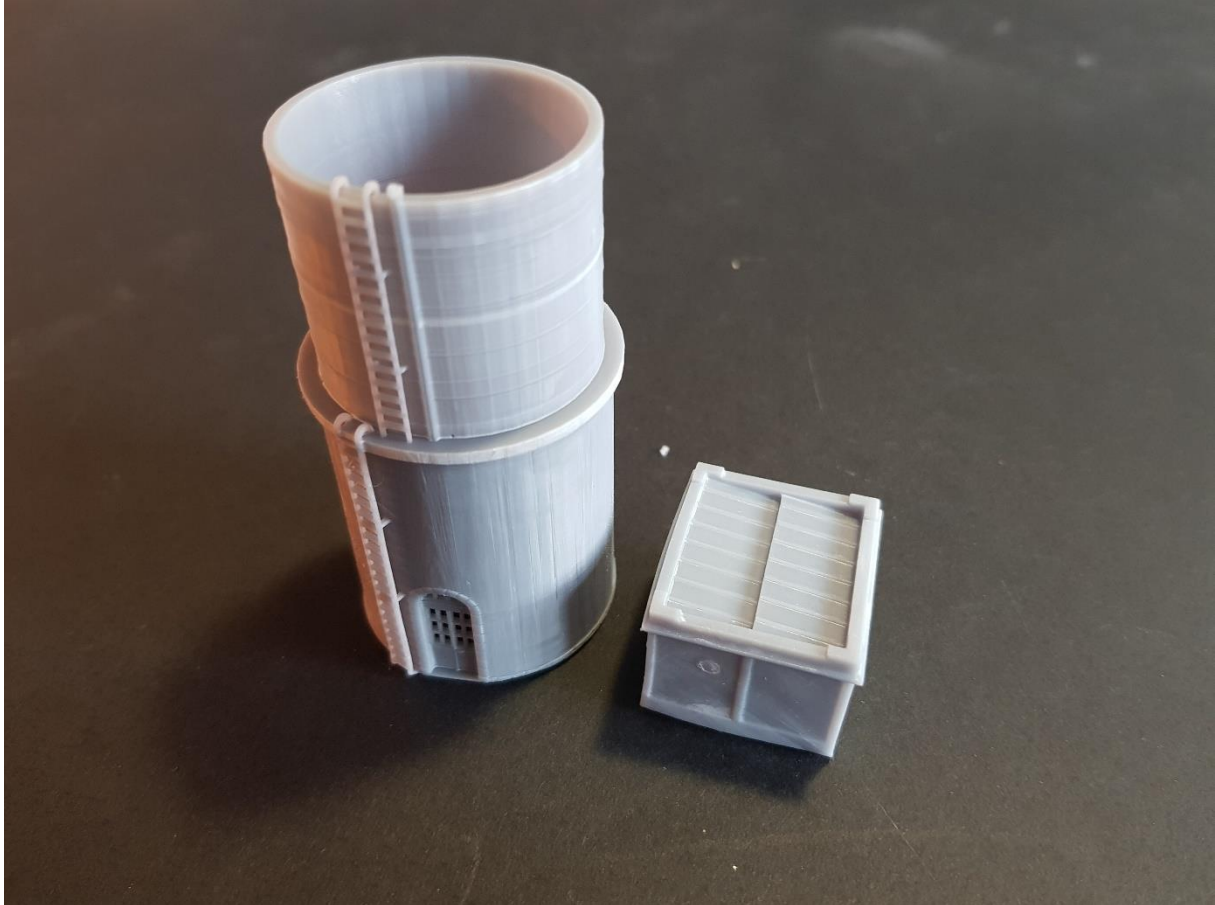



Le remise 2 locos - type PO 50 €
DIMENSIONS MAXIMALES : longueur = 135mm, profondeur = 105mm, hauteur = 57mm

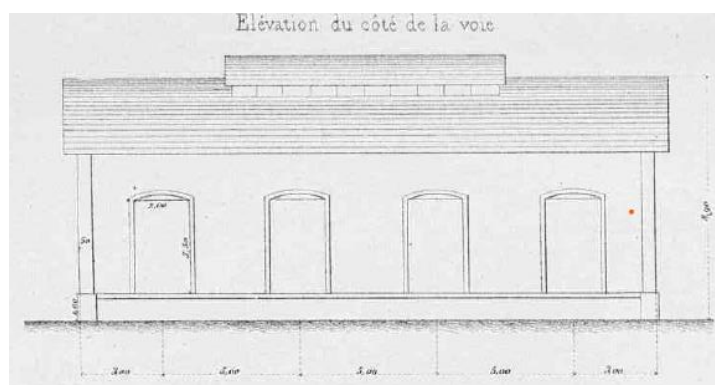

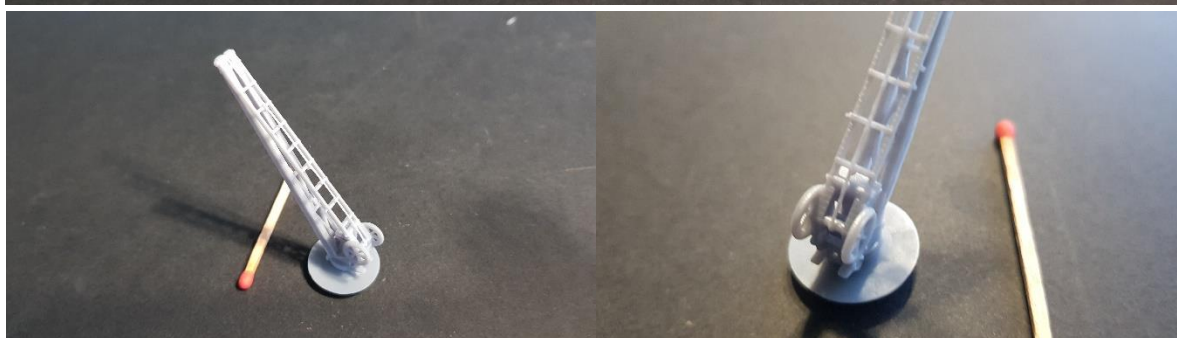
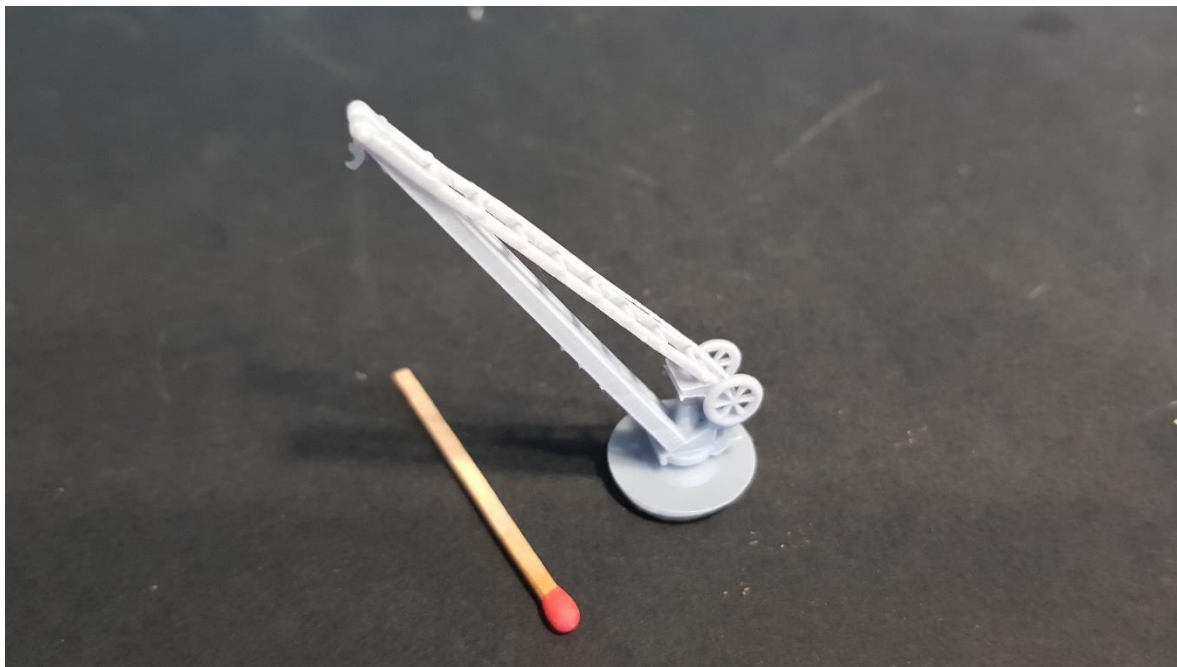

Grue de 6 tonnes - Ouest-Etat _____ 10 €

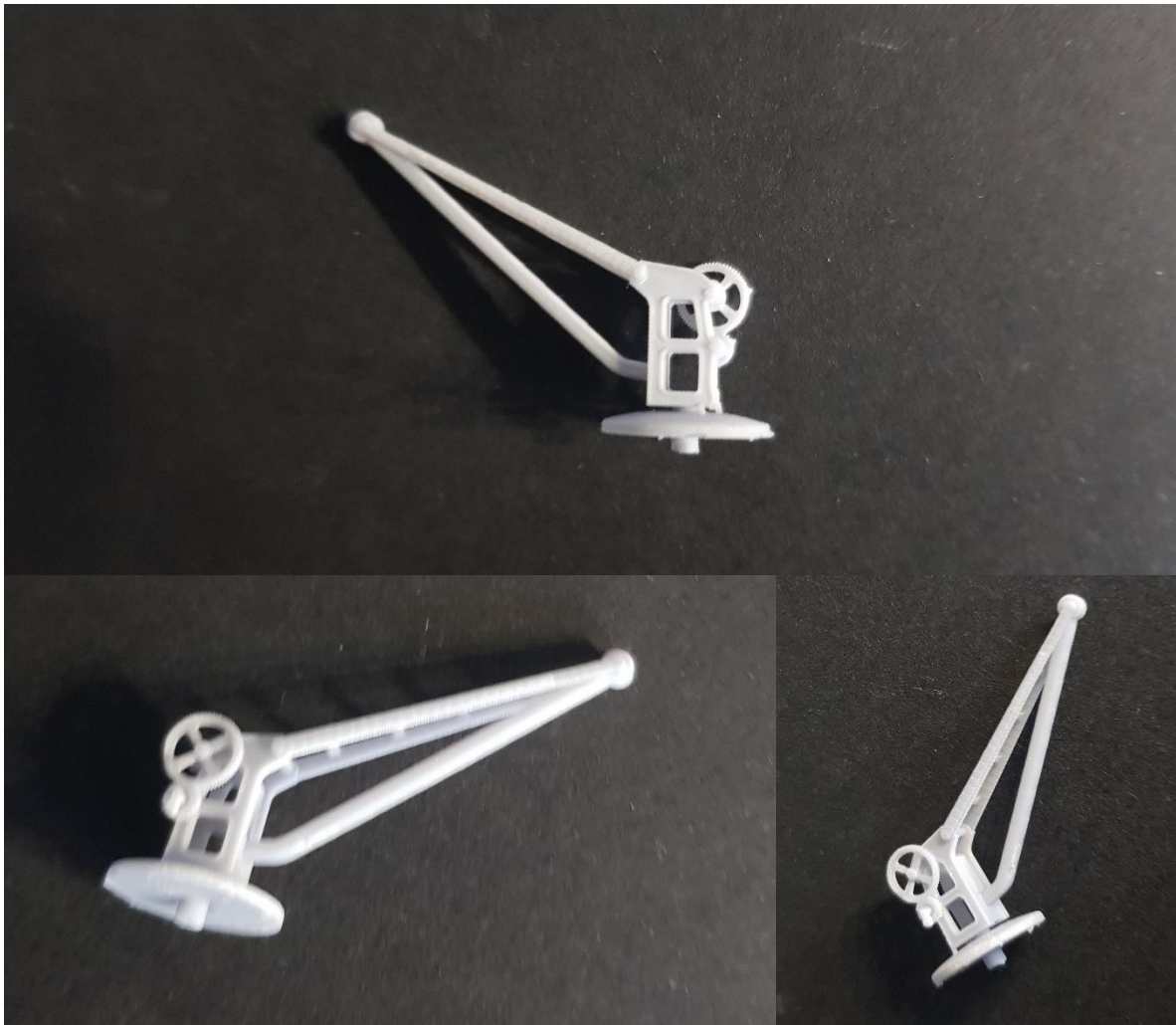
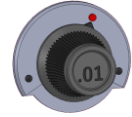

Grue de quai légère _____ 8 €

S.P.A.O.

12 rue Alain-fourmier

53000 Laval

0619443310 - stpoup1@gmail.com

N°Siret : 891 865 883 00013

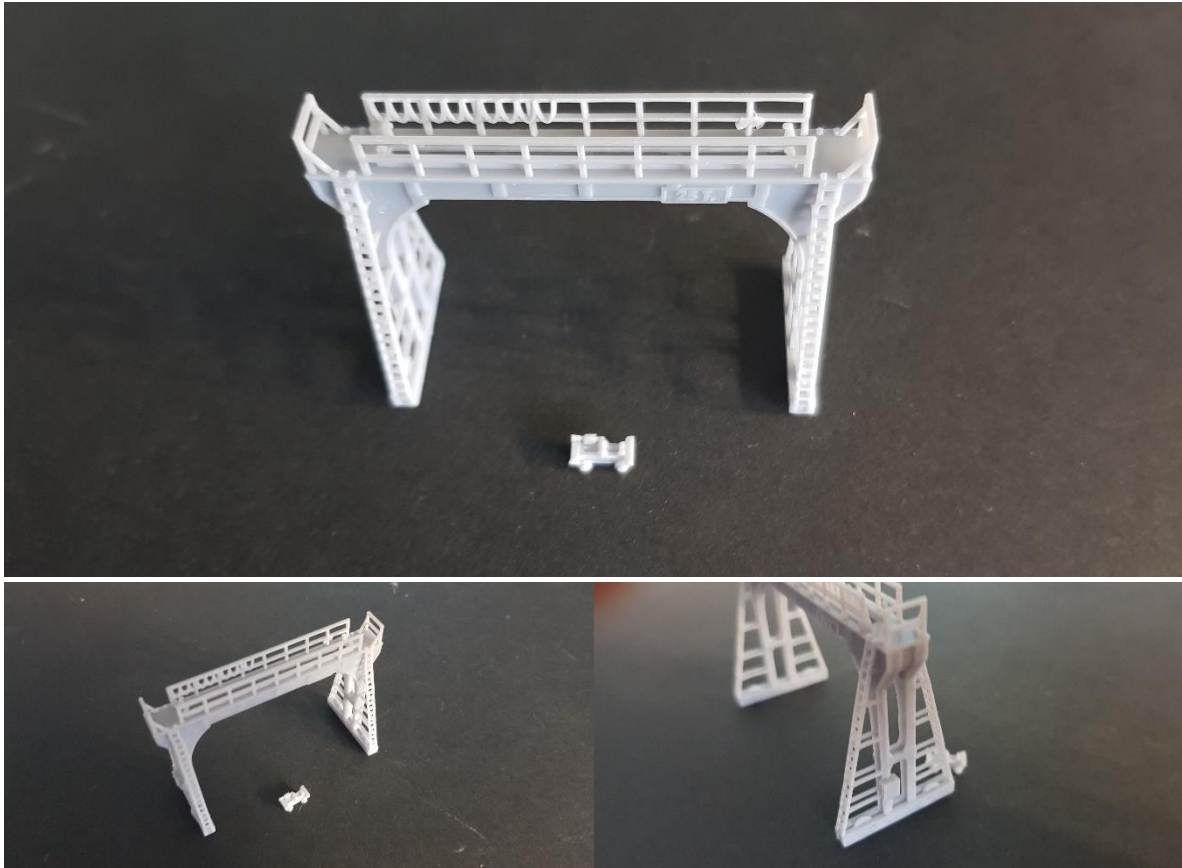
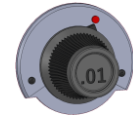

Portique 25 T avec Chariot

15 €

S.P.A.N

12 rue Alain-fournier

53000 Laval

0619443310 - stpoup1@gmail.com

N°Siret : 891 865 883 00013

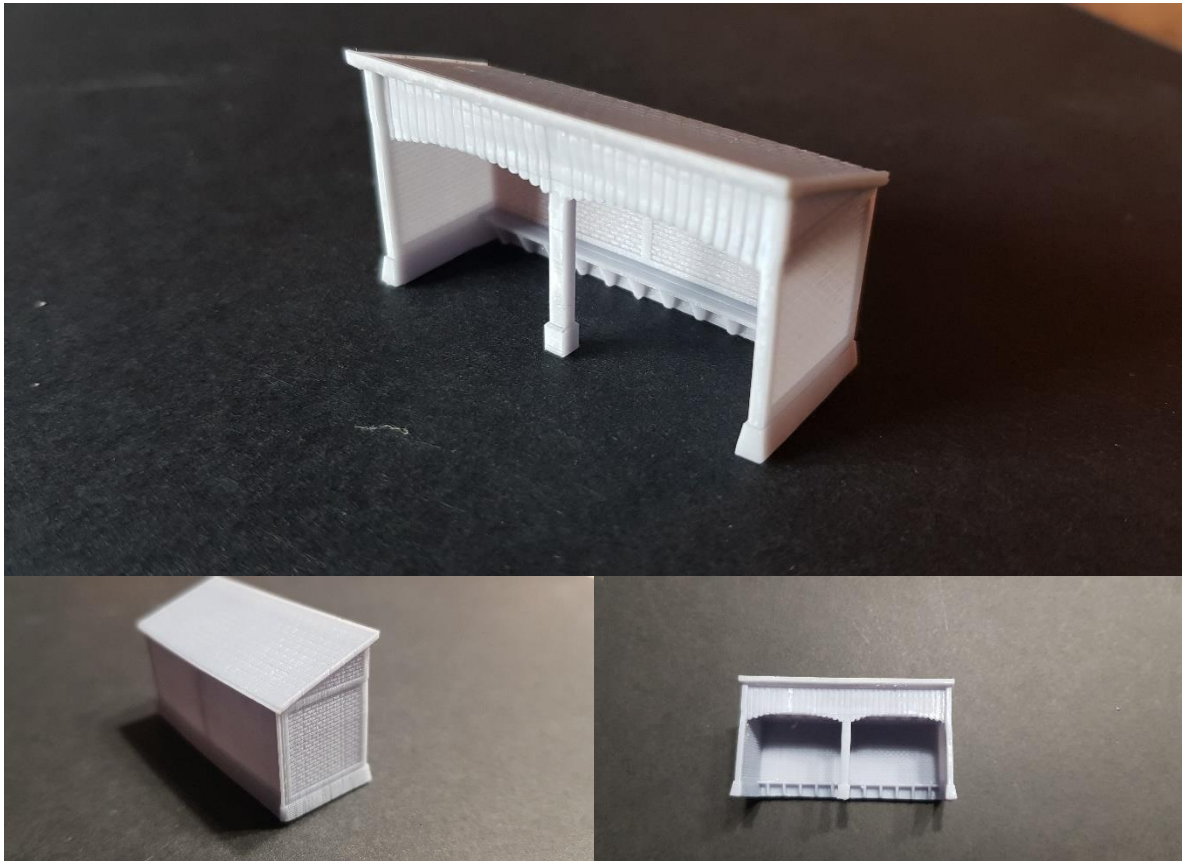
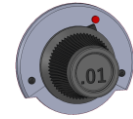

Abri voyageur type « EST » 10 €
DIMENSIONS MAXIMALES : longueur = 50mm, profondeur = 18mm, hauteur = 27mm

S.P.A.N

12 rue Alain-fournier

53000 Laval

0619443310 - stpoup1@gmail.com

N°Siret : 891 865 883 00013



Modélisme au 160^{ème} en impression 3D

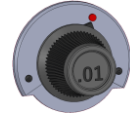

Maisons et commerces

S.P.A.N

12 rue Alain-fournier

53000 Laval

0619443310 - stpoup1@gmail.com

N°Siret : 891 865 883 00013



La maison du fleuriste et sa boutique _____ 25 €
La façade seule (avant ou arrière est vendue 15€)

DIMENSIONS MAXIMALES : longueur = 66 mm, profondeur = 56 mm, hauteur = 63 mm

S.P.A.N

12 rue Alain-fourmier

53000 Laval

0619443310 - stpoup1@gmail.com

N°Siret : 891 865 883 00013



La maison du cordonnier et sa boutique _____ 25 €

La façade seule (avant ou arrière est vendue 15€)

DIMENSIONS MAXIMALES : longueur = XX mm, profondeur = xx mm, hauteur = xx mm

S.P.A.N

12 rue Alain-fourmier

53000 Laval

0619443310 - stpoup1@gmail.com

N°Siret : 891 865 883 00013



La boulangerie et le garage _____ 25 €
La façade seule (avant ou arrière est vendue 15€)

DIMENSIONS MAXIMALES : longueur = 84 mm, profondeur = 48 mm, hauteur = 66 mm

S.P.A.N

12 rue Alain-fourmier

53000 Laval

0619443310 - stpoup1@gmail.com

N°Siret : 891 865 883 00013

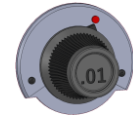

La boucherie et la boulangerie 45 €
La façade seule (avant ou arrière est vendue 25€)

DIMENSIONS MAXIMALES : longueur = 138 mm, profondeur = 57 mm, hauteur = 68 mm

S.P.A.N

12 rue Alain-fournier

53000 Laval

0619443310 - stpoup1@gmail.com

N°Siret : 891 865 883 00013

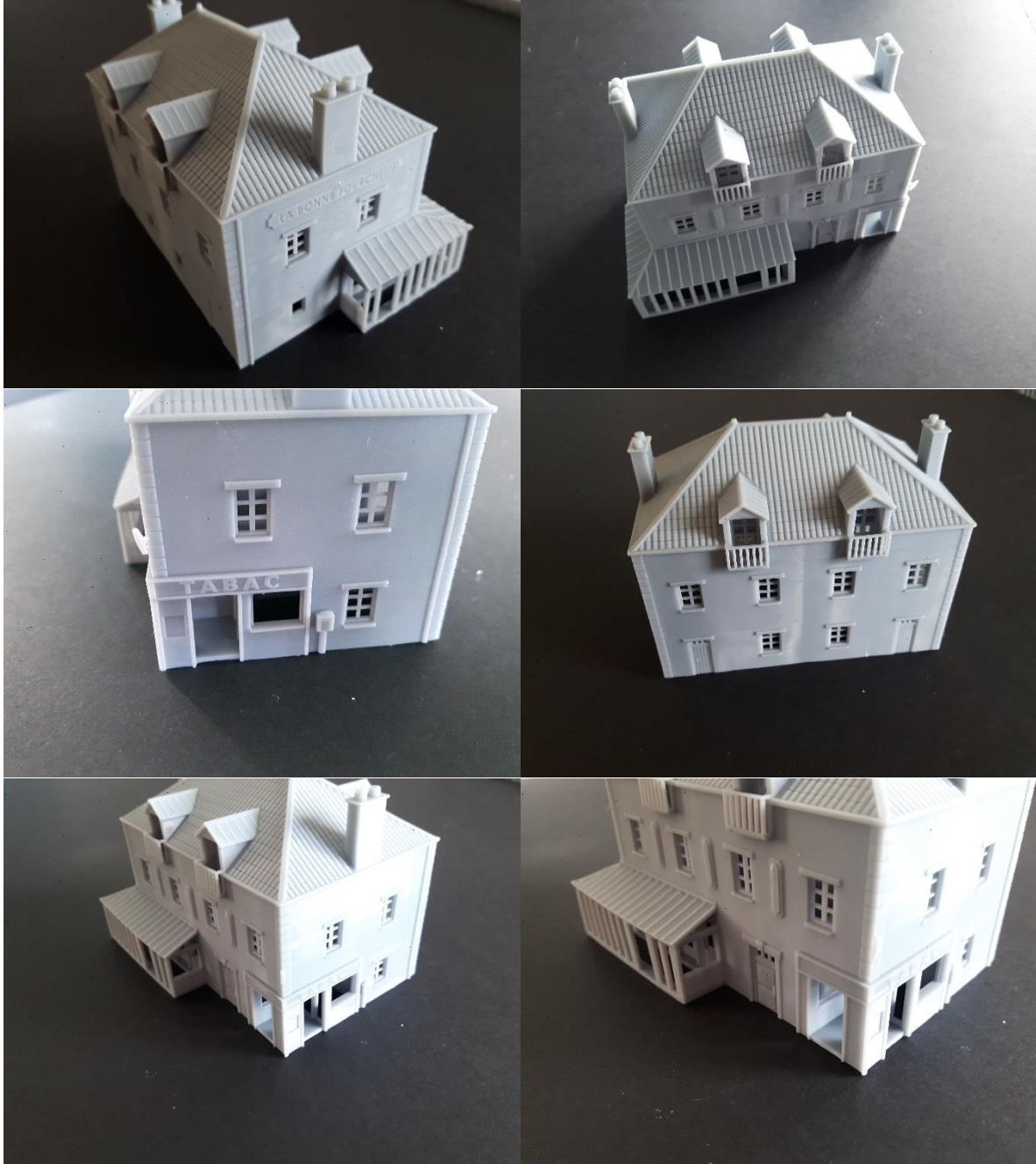
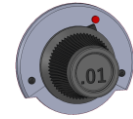

Le restaurant « La Bonne Fourchette » et le tabac _____ 30 €

DIMENSIONS MAXIMALES : longueur = 97 mm, profondeur = 70 mm, hauteur = 72 mm

S.P.A.N

12 rue Alain-fourrier

53000 Laval

0619443310 - stpoup1@gmail.com

N°Siret : 891 865 883 00013

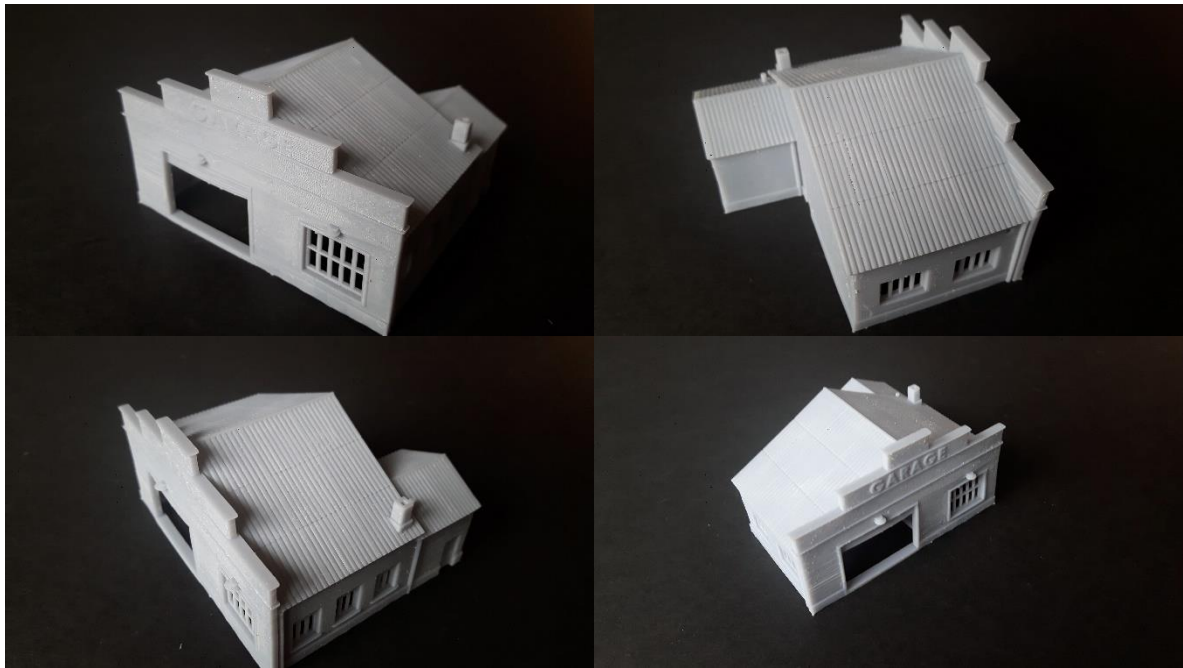
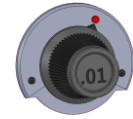

Le garage 30€

DIMENSIONS MAXIMALES : longueur = 97 mm, profondeur = 70 mm, hauteur = 72 mm



L'école et son préau _____ 50€

DIMENSIONS MAXIMALES : longueur = 166 mm, profondeur = 57 mm.

Le mur d'enceinte longueur 40mm (composé d'un pilier d'un muret et de la grille et/ou grille +porte = 3€Pièce



La mairie

35€

DIMENSIONS MAXIMALES : longueur = 126 mm, profondeur = 71 mm.

S.P.A.N

12 rue Alain-fournier

53000 Laval

0619443310 - stpoup1@gmail.com

N°Siret : 891 865 883 00013



La ferme Beauceronne



L'habitation (75mm x 46mm) – 30€



L'étable (90mm x 48mm) – 30€



Le pigeonnier (39mm x 39mm - 30€



La grange (78mm x 52mm) – 30€



Porche complet (74mm x 4mm) – 10€



Mur d'enceinte* (54mm x 4 mm) – 4€

* 2 modèles aux choix avec ou sans porte – le puit est offert pour toute commande



Modélisme au 160^{ème} en impression 3D

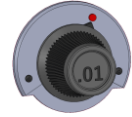

Décors et accessoires

S.P.A.N

12 rue Alain-fournier

53000 Laval

0619443310 - stpoup1@gmail.com

N°Siret : 891 865 883 00013



Le château d'eau et sa station de pompage _____ 25 €

DIMENSIONS MAXIMALES : longueur = 45 mm, profondeur = 44 mm, hauteur = 90 mm

S.P.A.N

12 rue Alain-fourrier

53000 Laval

0619443310 - stpoup1@gmail.com

N°Siret : 891 865 883 00013

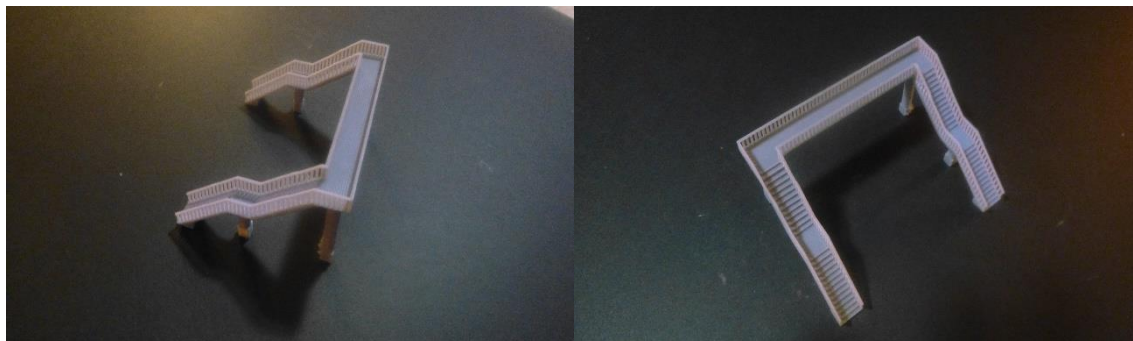
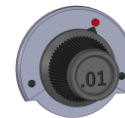

Passerelle _____ 20€

DIMENSIONS MAXIMALES : longueur = 115 mm, profondeur = 75 mm, hauteur = 45 mm

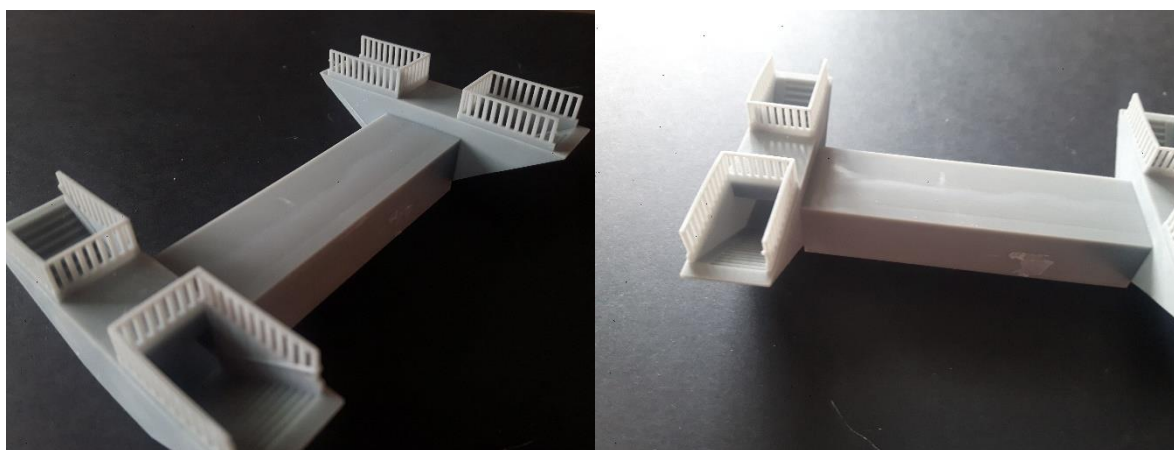

Passage souterrain (quai) _____ 20€

DIMENSIONS MAXIMALES : longueur = 127 mm, profondeur = 80 mm, hauteur = 30 mm



Paire de barrières (fixes) _____ 8€
(Modèle battante 2 vantaux + portillon ou oscillante + portillon)

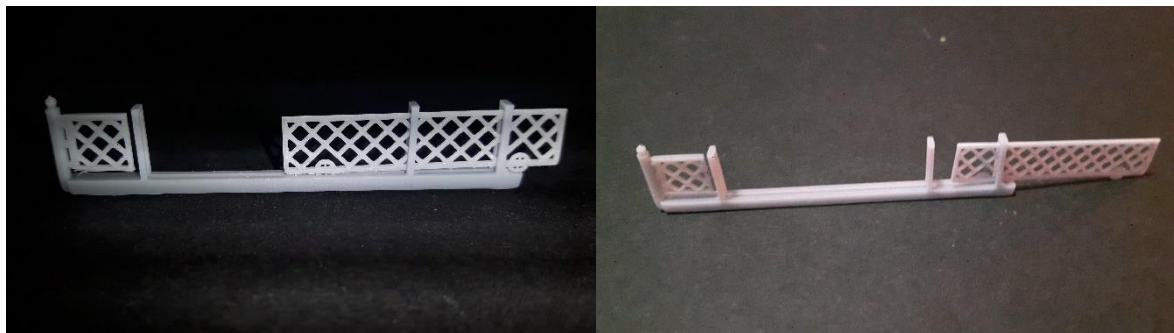

Paire de barrières (mobile) _____ 8€
(Modèle roulante – roues fictives) – longueur totale 55mm (fermée)

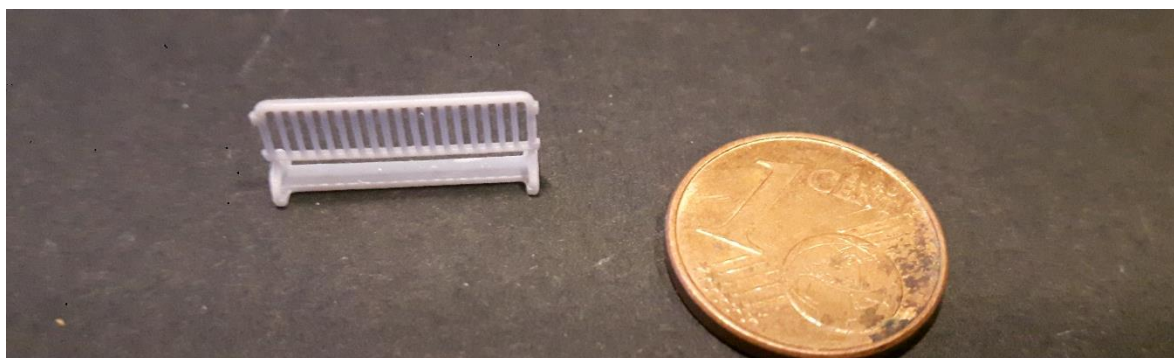

Barrière anti-émeute (lot de 10) _____ 15€

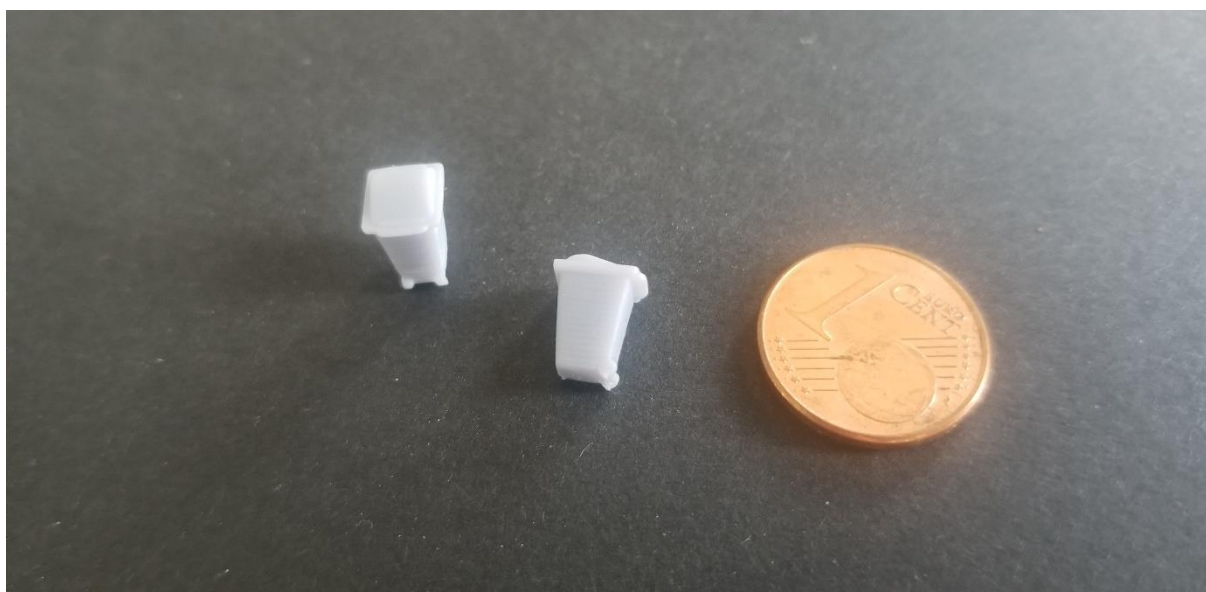

Poubelle de ville (lot de 10) _____ 15€

S.P.A.N

12 rue Alain-fourmier

53000 Laval

0619443310 - stpoup1@gmail.com

N°Siret : 891 865 883 00013

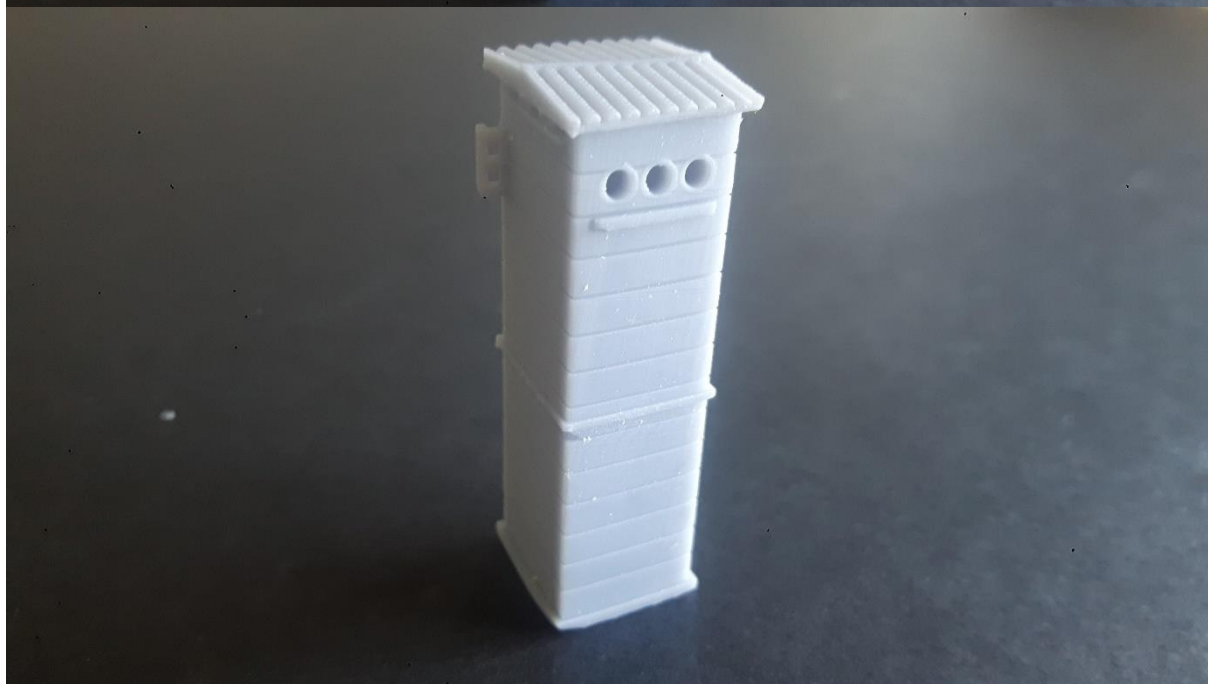

Transformateur EDF (N) _____ 8€
Transformateur EDF (Ho) _____ 10€

DIMENSIONS MAXIMALES : longueur = 14 mm, profondeur = 15 mm, hauteur = 47 mm

S.P.A.O

12 rue Alain-fourmier

53000 Laval

0619443310 - stpoup1@gmail.com

N°Siret : 891 865 883 00013

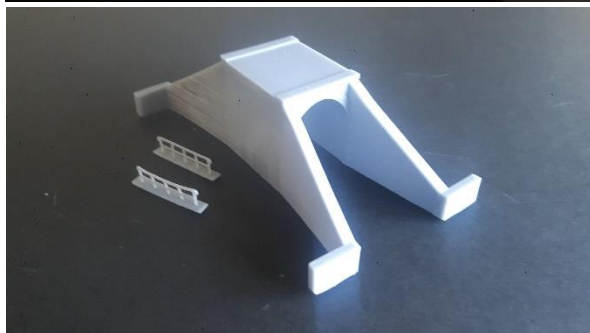
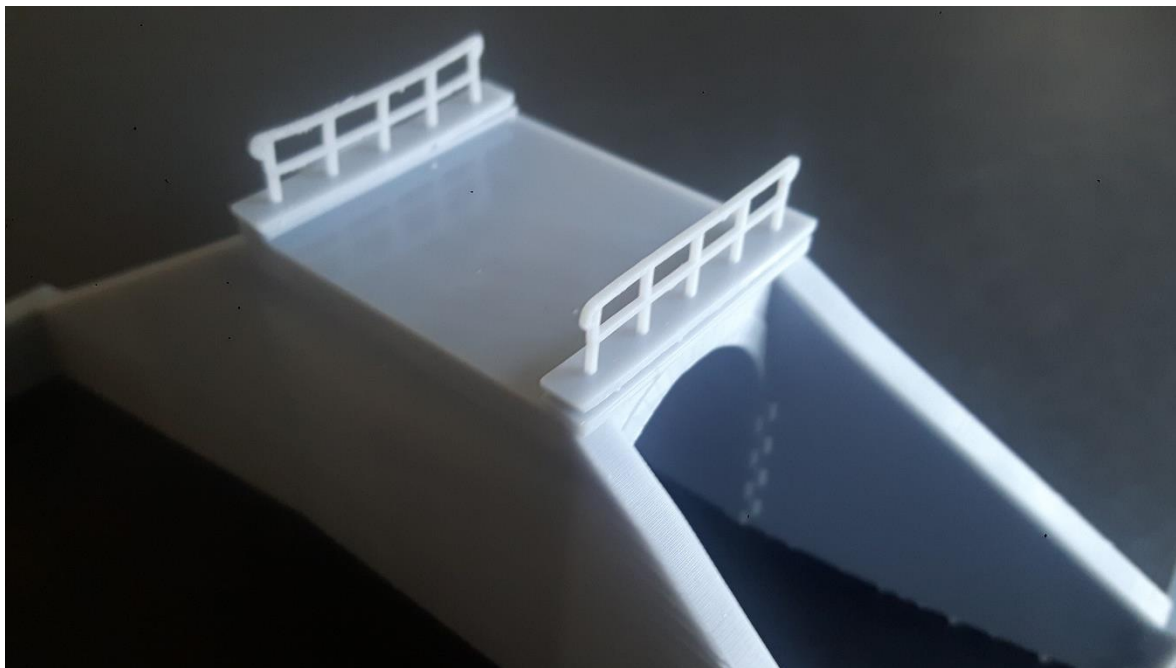

Le pont voûté de 4 m d'ouverture _____ 25€

DIMENSIONS MAXIMALES : longueur = 71 mm, profondeur = 125 mm, hauteur = 28 mm

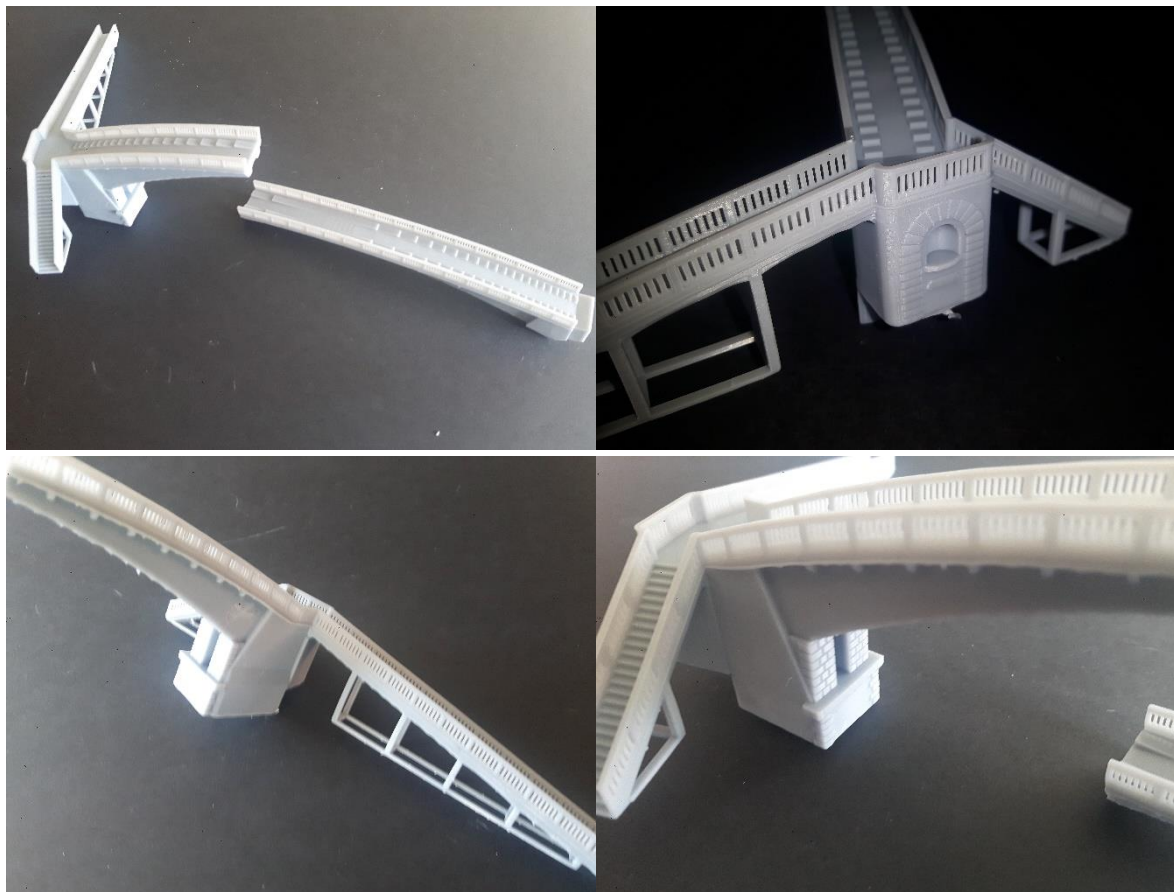

La passerelle Maitre Ecole à Angers (2 pièces à assembler !) _____ 60€



DIMENSIONS MAXIMALES : longueur = 127 mm, profondeur = 80 mm, hauteur = 30 mm

S.P.A.N

12 rue Alain-fourmier

53000 Laval

0619443310 - stpoup1@gmail.com

N°Siret : 891 865 883 00013

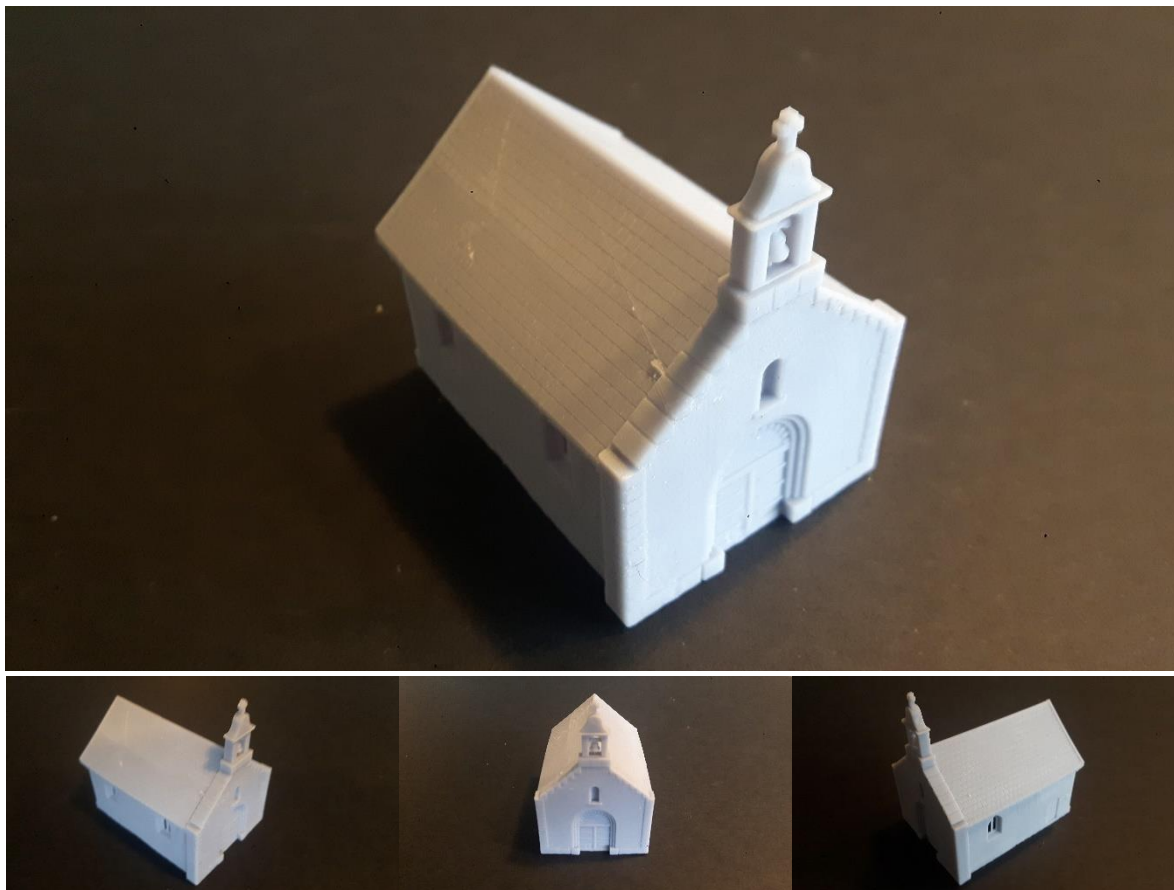

La chapelle _____ 12€

DIMENSIONS MAXIMALES : longueur = 42 mm, profondeur = 57 mm, hauteur = 63 mm

S.P.A.N

12 rue Alain-fourrier

53000 Laval

0619443310 - stpoup1@gmail.com

N°Siret : 891 865 883 00013

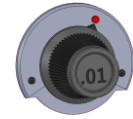

La chapelle romane _____ 12€

DIMENSIONS MAXIMALES : longueur = 66 mm, largeur = 60 mm

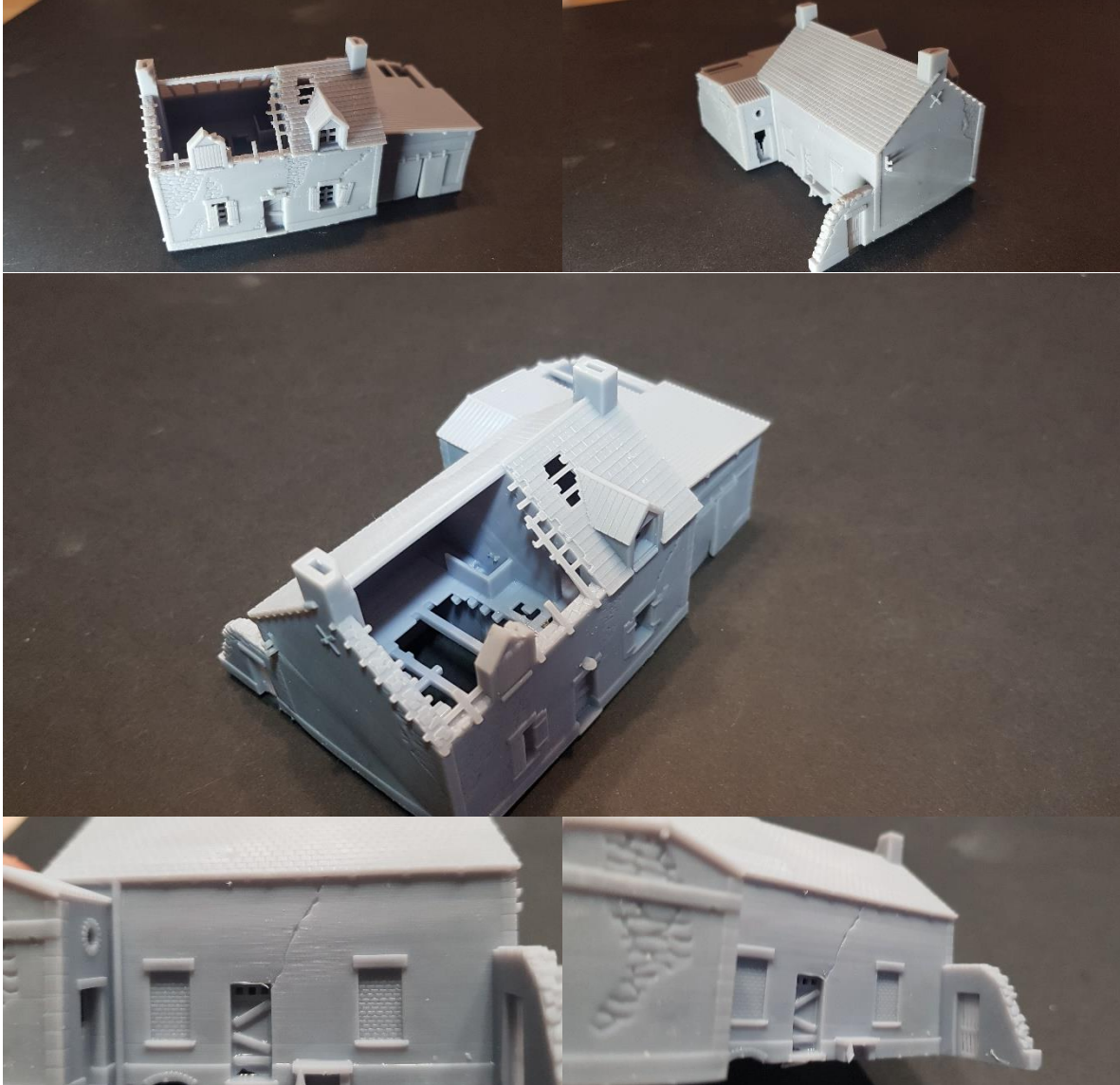
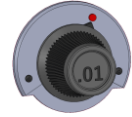

La maison en ruine

25€

S.P.A.N

12 rue Alain-fourrier

53000 Laval

0619443310 - stpoup1@gmail.com

N°Siret : 891 865 883 00013

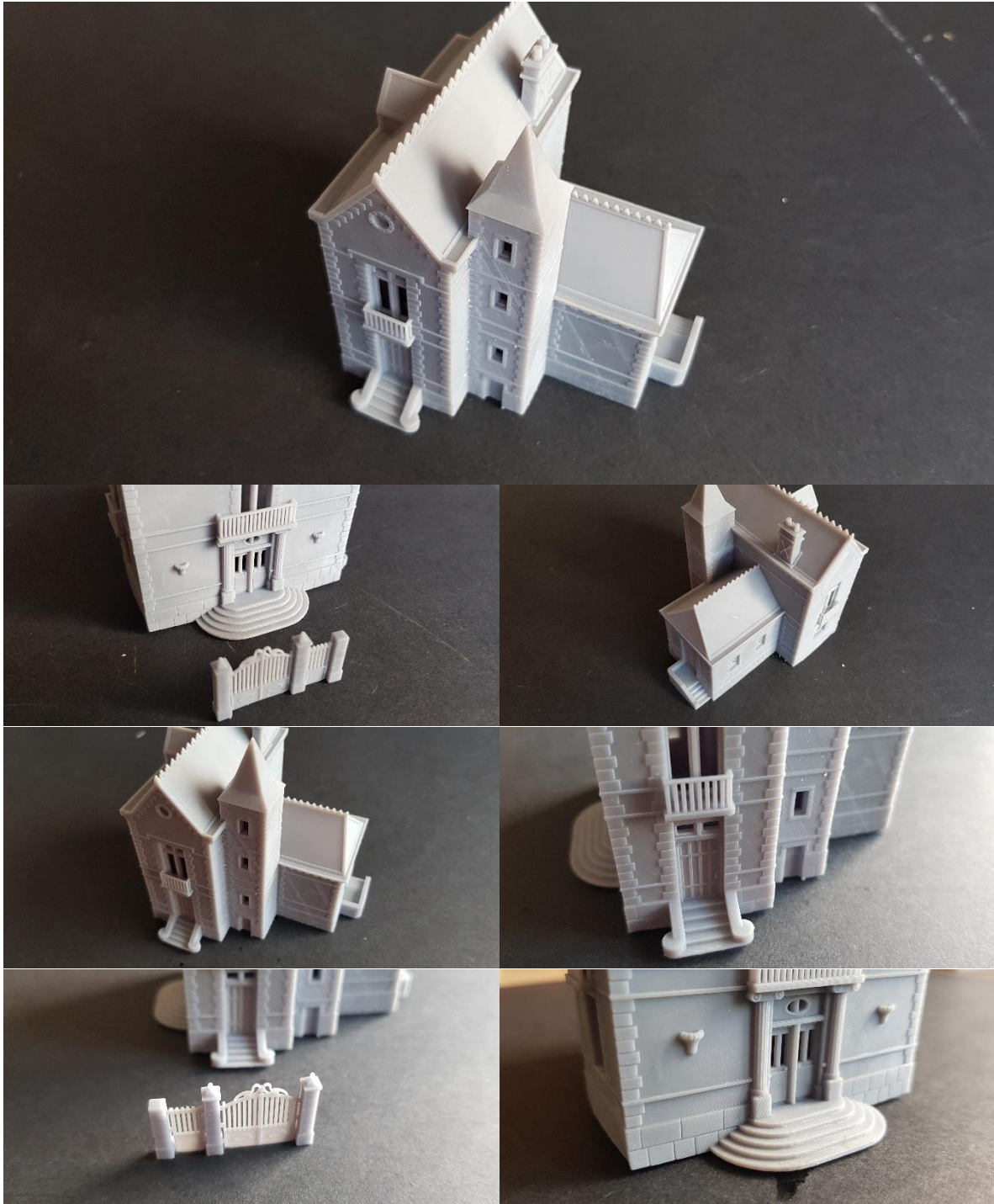
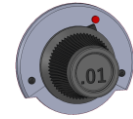

Le Manoir et sa grille

35€

S.P.A.N

12 rue Alain-fourmier

53000 Laval

0619443310 - stpoup1@gmail.com

N°Siret : 891 865 883 00013

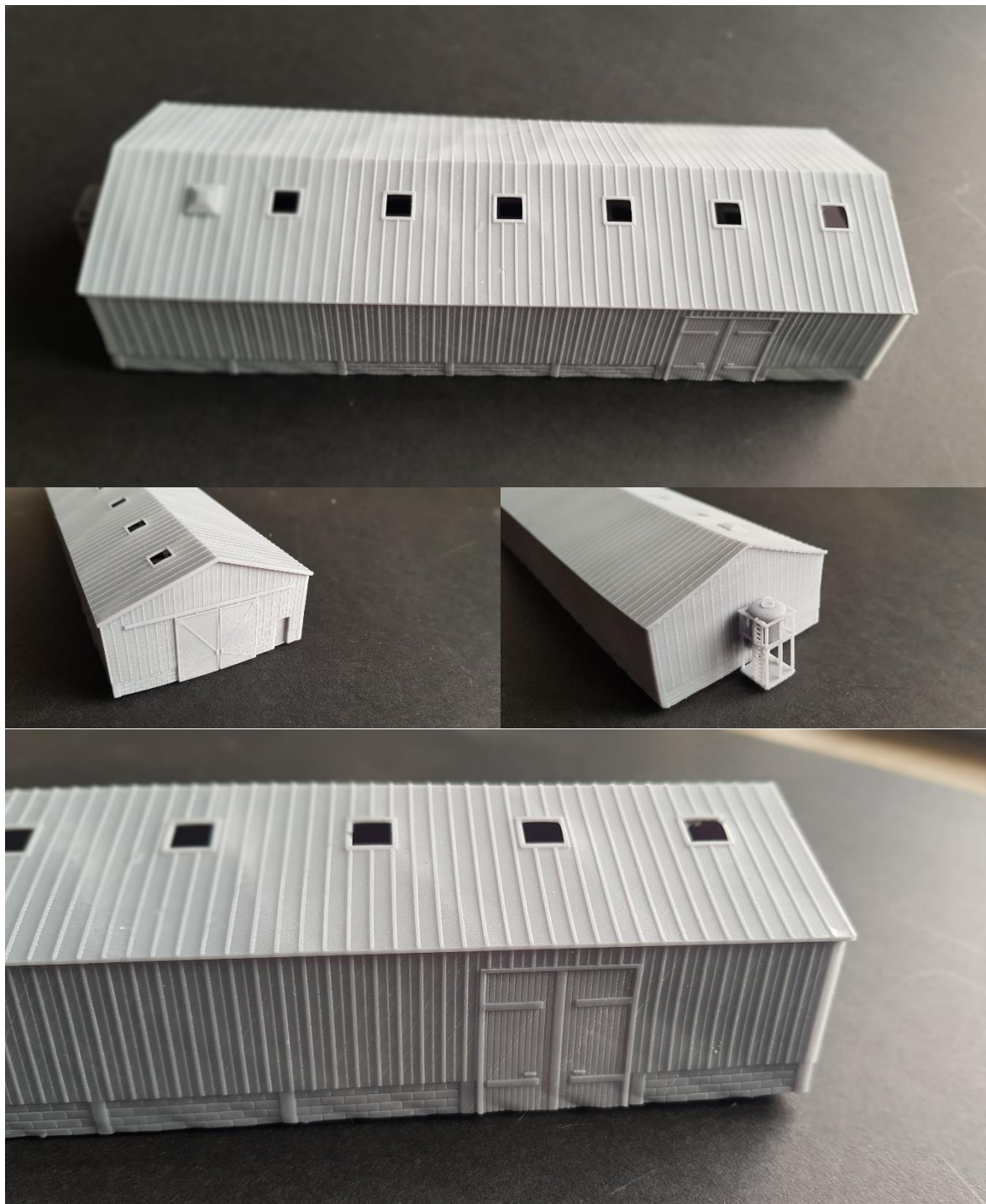

Le hangar agricole _____ **40€**
DIMENSIONS MAXIMALES : longueur = 202mm, profondeur = 70mm, hauteur = 42mm

S.P.A.N

12 rue Alain-fourmier

53000 Laval

0619443310 - stpoup1@gmail.com

N°Siret : 891 865 883 00013



Le monument aux morts* (1/160) _____ 10€

DIMENSIONS MAXIMALES : longueur = 16mm, profondeur = 16mm, hauteur = 37mm

Le monument aux morts (1/87) _____ 18€

DIMENSIONS MAXIMALES : longueur = 25mm, profondeur = 25mm, hauteur = 58mm



Le poilu victorieux - Vouvant (85)

*La résolution de l'imprimante ne permet pas de reproduire le fusil et les lauriers

S.P.A.N

12 rue Alain-fournier

53000 Laval

0619443310 - stpoup1@gmail.com

N°Siret : 891 865 883 00013

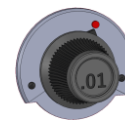

Accessoires de quai

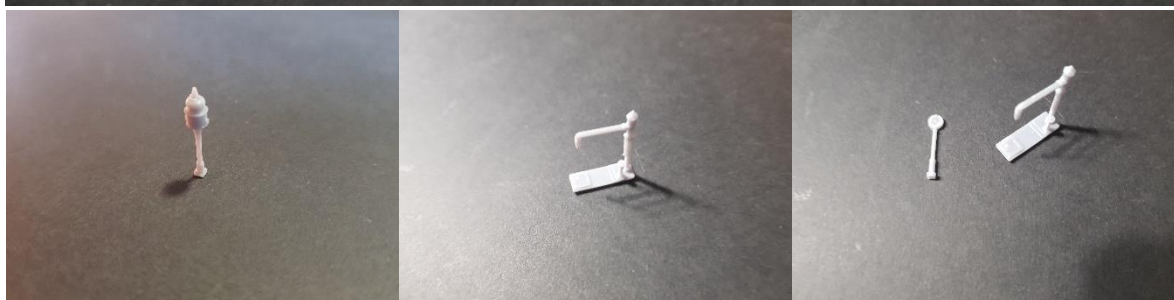
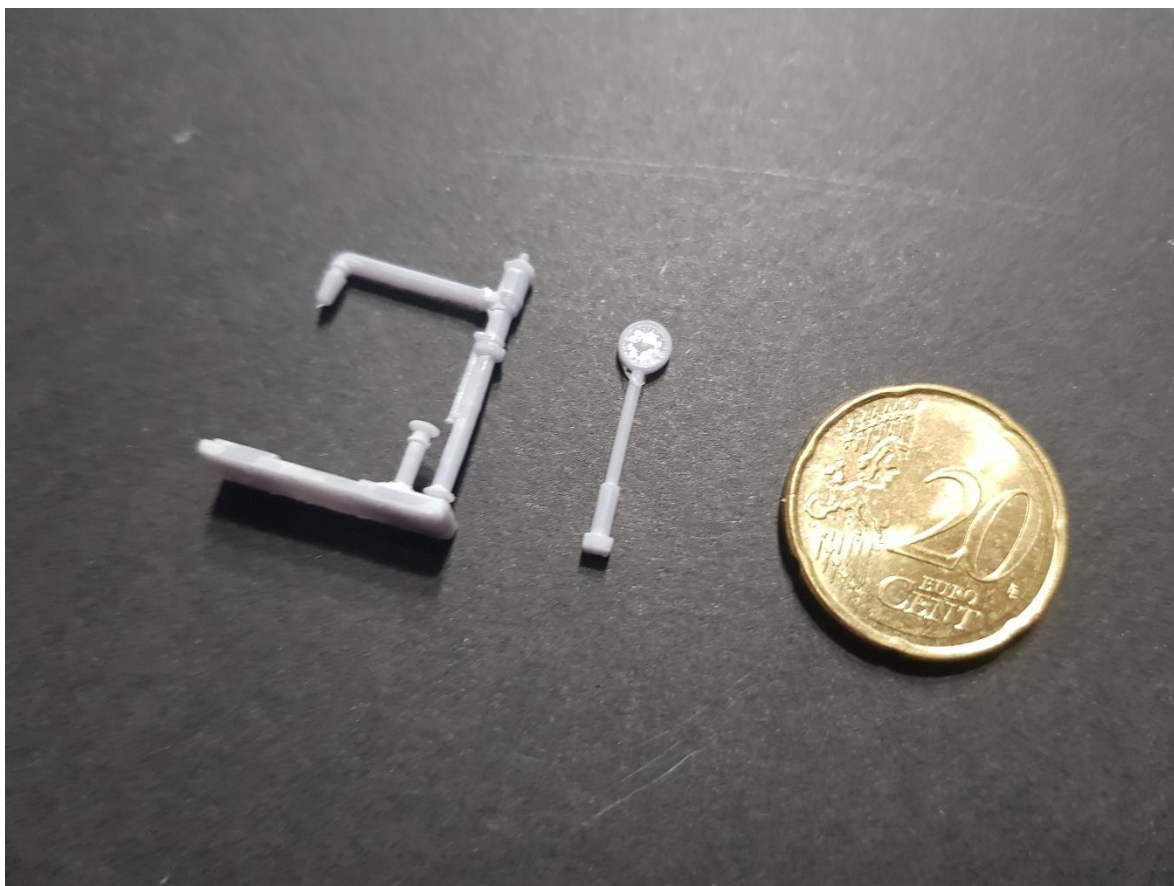

Accessoires de quai (horloge + prise d'eau + cloche d'appel) – les 10 pièces* _____ 12€ (N)

Accessoires de quai (horloge + prise d'eau + cloche d'appel) – les 10 pièces* _____ 18€ (Ho)

* Possibilité de panacher

S.P.A.N

12 rue Alain-fourmier

53000 Laval

0619443310 - stpoup1@gmail.com

N°Siret : 891 865 883 00013

Le poste d'aiguillage

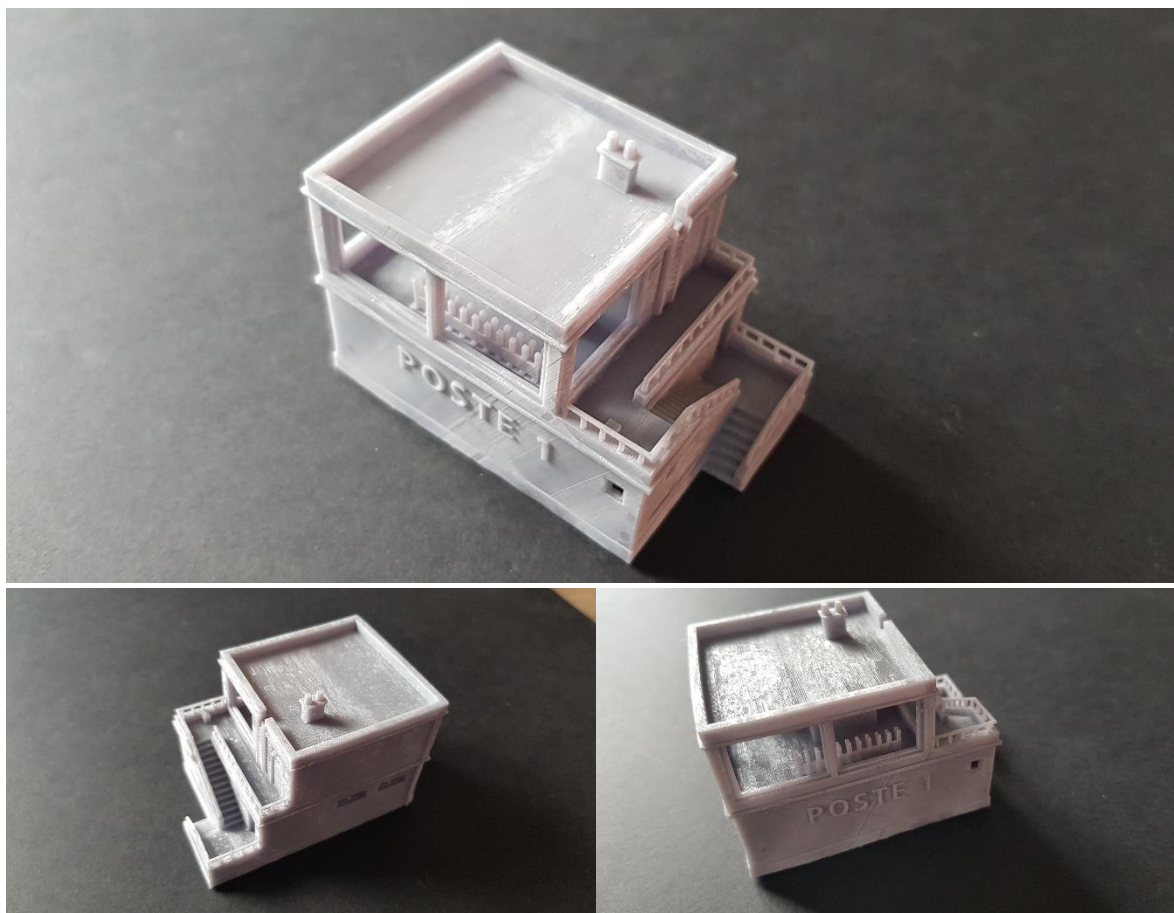

Le poste d'aiguillage _____ 15€

DIMENSIONS MAXIMALES : longueur = 67mm, profondeur = 4mm, hauteur = 42mm



Le panneau de repérage

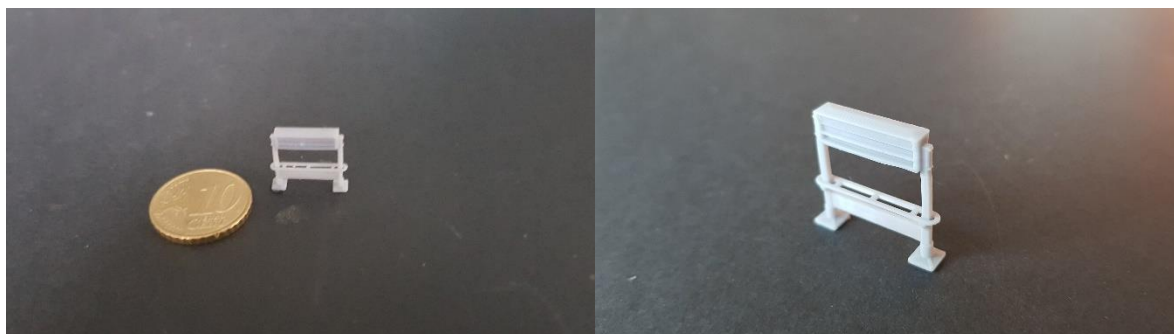

Vendu par 2 (N) _____ **8€**
Vendu par 2 (Ho) _____ **12€**

Le chariot porte-bagages et ses wagonnets

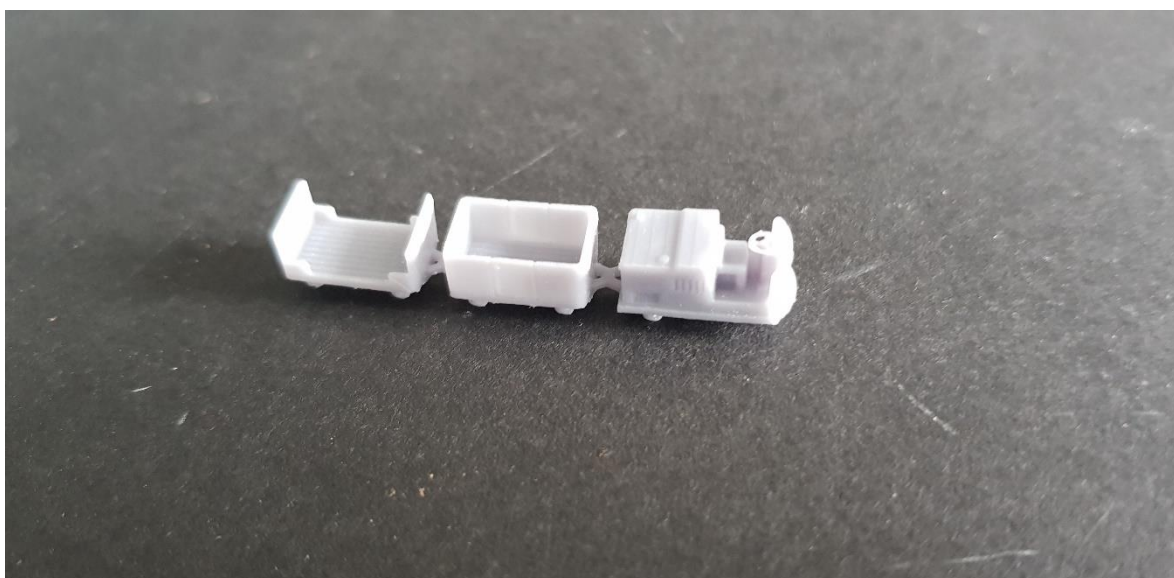

Modèle fixe et non roulant (longueur 45mm environ) N _____ **5€**
Modèle fixe et non roulant (longueur 82mm environ) Ho _____ **9€**



Signalétique SNCF – accessoires

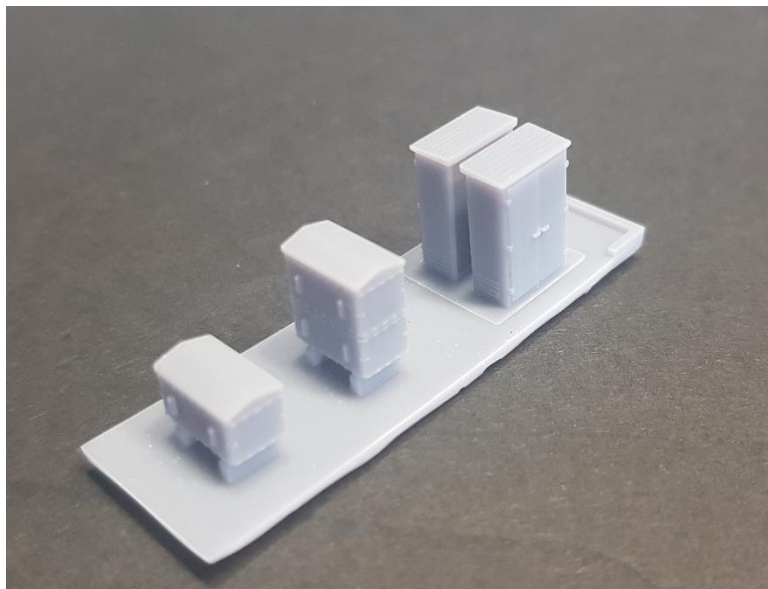

Boite à piles + armoires électriques = 5€ (dimensions 50mm x 15.5mm)



Portique « feux » = 3€ (statique)

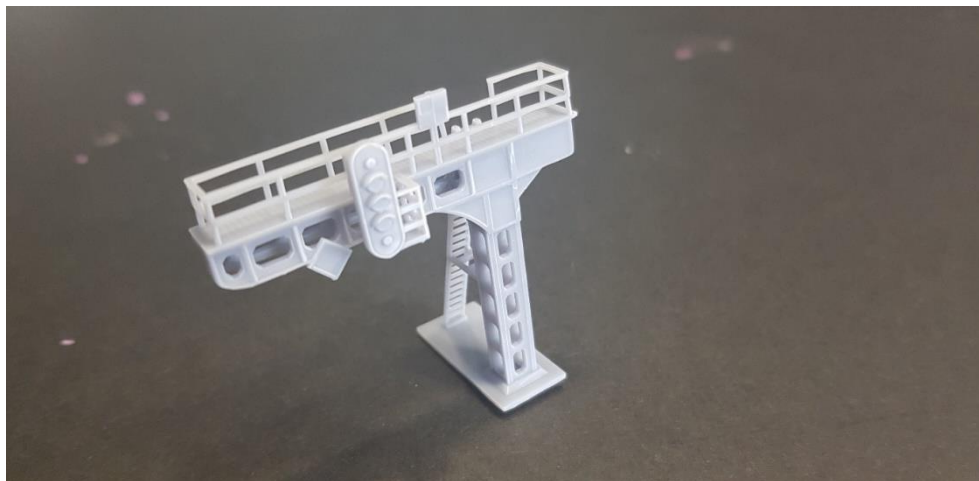

Portique signalisations simple = 8€

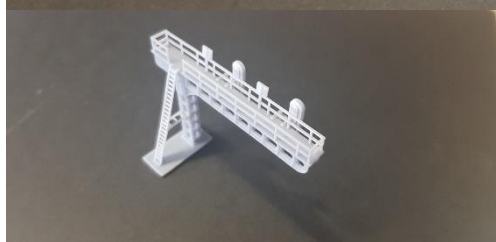

Portique signalisations double = 10€



Les décors de chantier



Les « algecos » (25€)

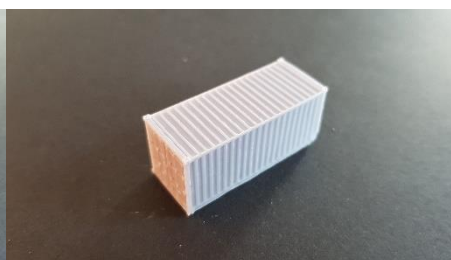

le conteneur 20 pieds (5€)



Le WC de chantier (2€)



la benne type 1 (5€)



la benne type 2 (5€)



le bureau de chantier (5€)



le conteneur 10pieds (5€)

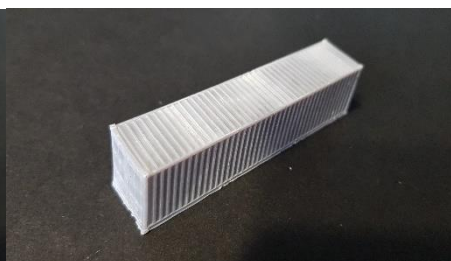

le conteneur 40pieds (7€)

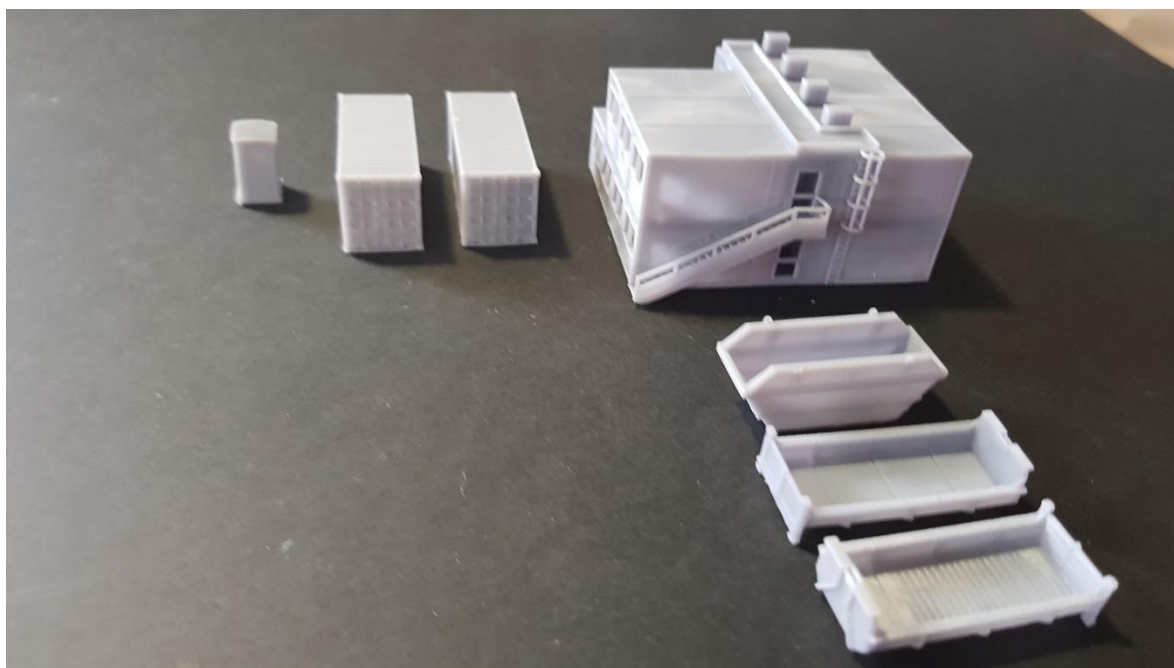

Le lot de chantier (6 pièces + algecos) = 45€

Possibilité de panacher

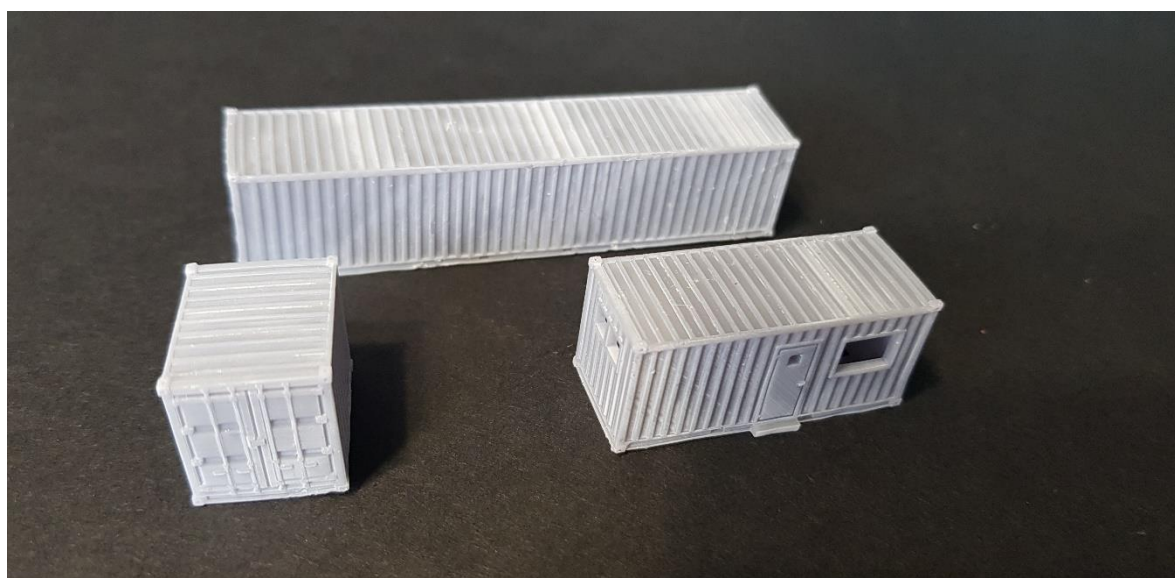

S.P.A.N

12 rue Alain-fourmier

53000 Laval

0619443310 - stpoup1@gmail.com

N°Siret : 891 865 883 00013



Modélisme au 160^{ème} en impression 3D

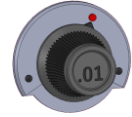

Véhicules (non roulants)

S.P.A.N

12 rue Alain-fourmier

53000 Laval

0619443310 - stpoup1@gmail.com

N°Siret : 891 865 883 00013

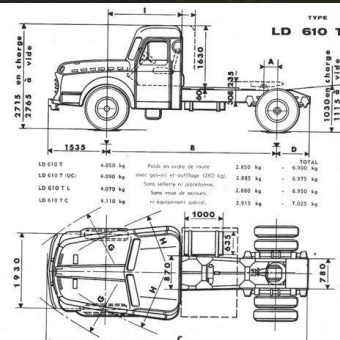
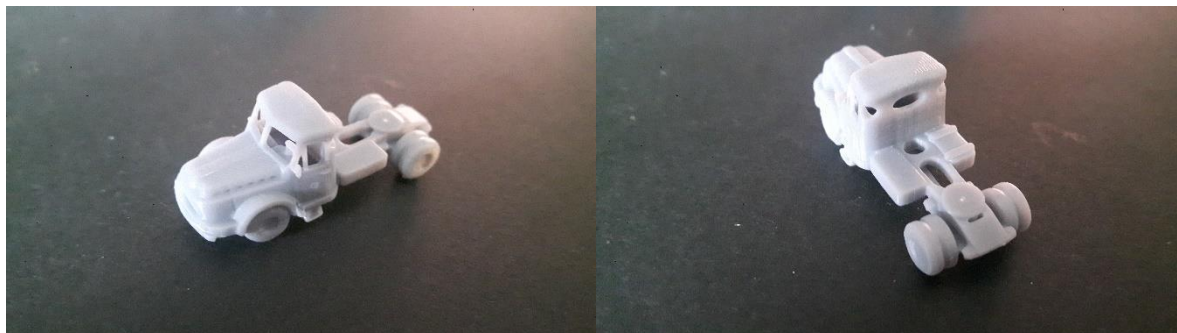

Camion WILLEME DT610

9€

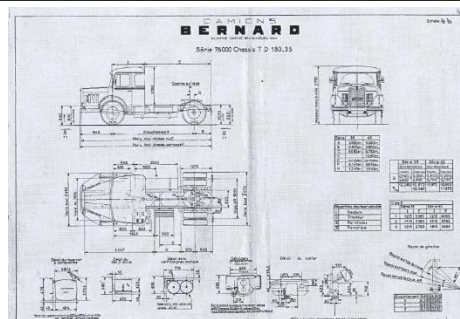

Camion BERNARD

9€

S.P.A.N

12 rue Alain-fourmier

53000 Laval

0619443310 - stpoup1@gmail.com

N°Siret : 891 865 883 00013

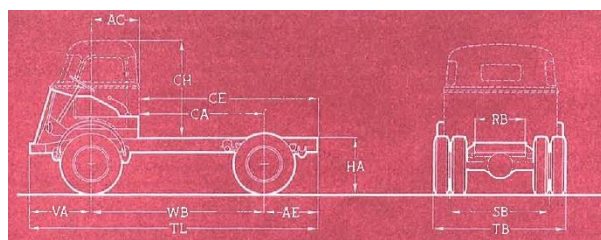
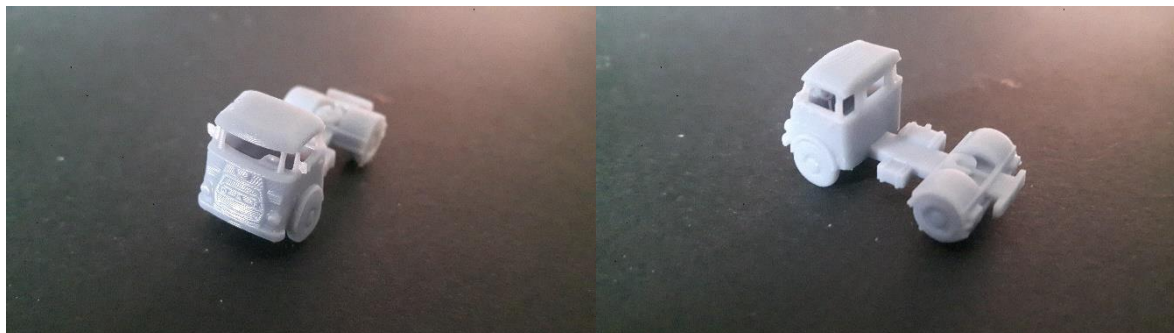

Camion DAF T1300

9€

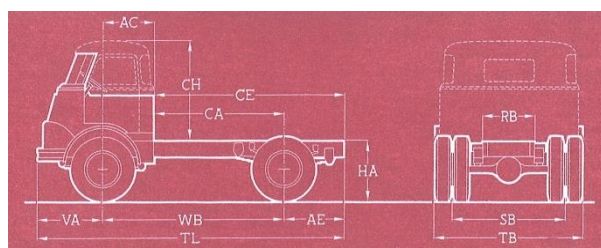

Camion DAF T2000

€

S.P.A.N

12 rue Alain-fourmier

53000 Laval

0619443310 - stpoup1@gmail.com

N°Siret : 891 865 883 00013

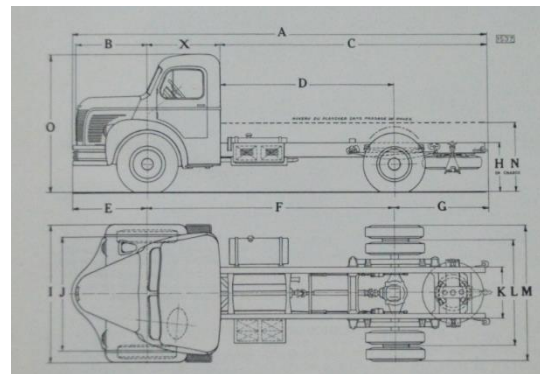
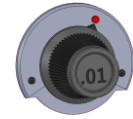

Camion BERLIET

9€

S.P.A.O.

12 rue Alain-fournier

53000 Laval

0619443310 - stpoup1@gmail.com

N°Siret : 891 865 883 00013

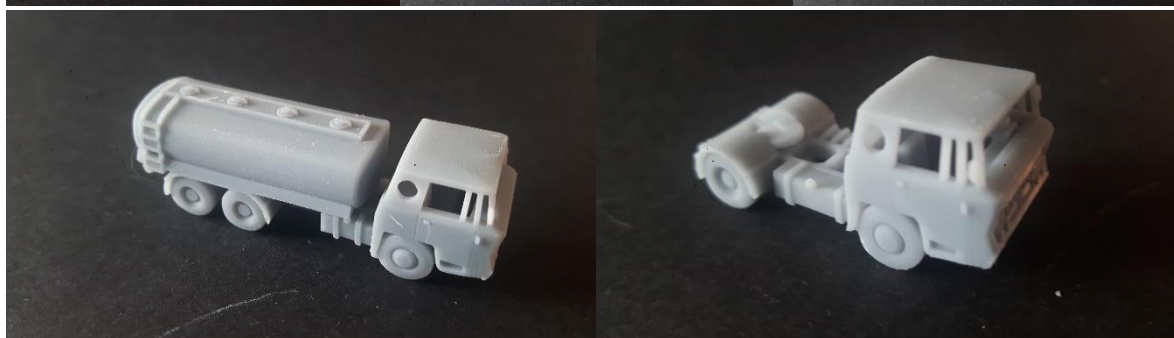

Camion BERNARD (série 76000) _____ 9€

5 modèles (plateau, benne, porteur, citerne ou tracteur !)

L'achat de 5 camions est au prix de 40€

S.P.A.N

12 rue Alain-fourmier

53000 Laval

0619443310 - stpoup1@gmail.com

N°Siret : 891 865 883 00013

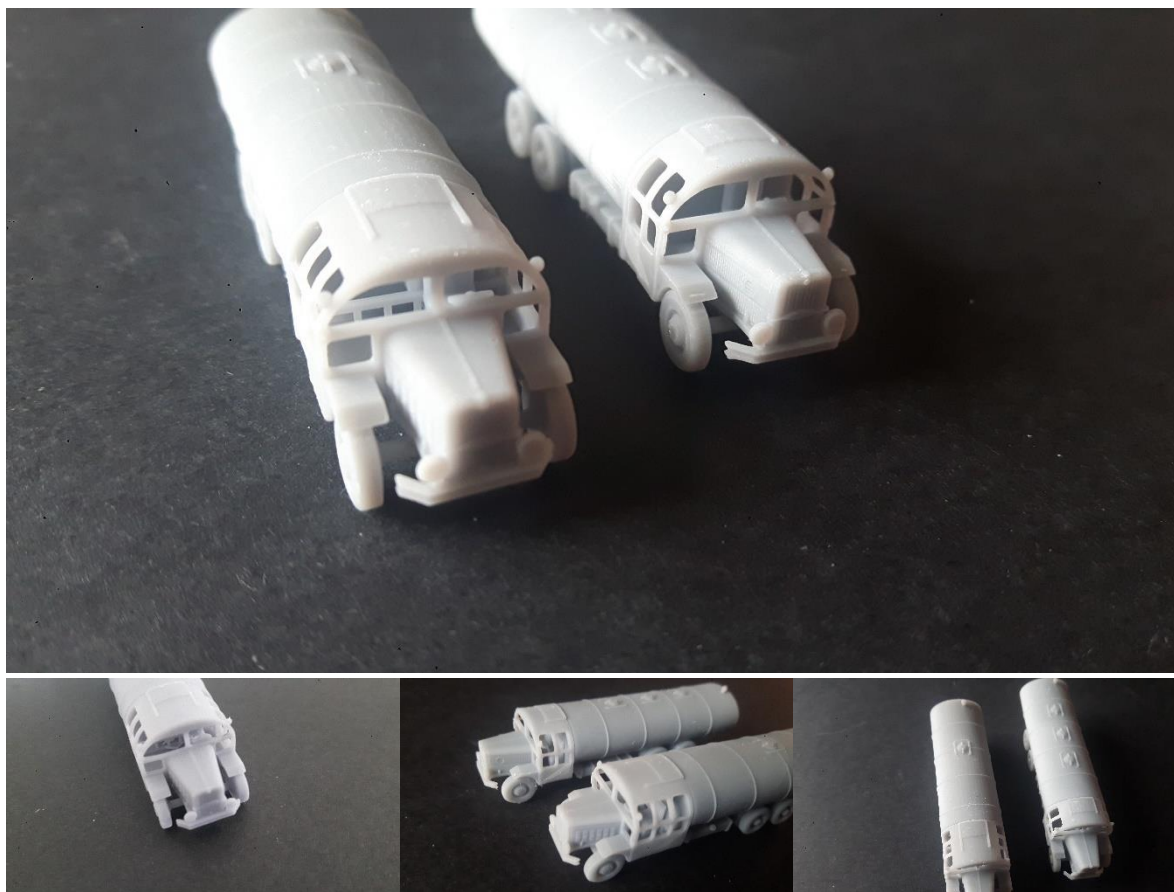

Camion BERNARD – entreprise Becquet (2 ou 3 vitres)

7€



S.P.A.O.

12 rue Alain-fourrier

53000 Laval

0619443310 - stpoup1@gmail.com

N°Siret : 891 865 883 00013



Camion Blindé (Mercedes)

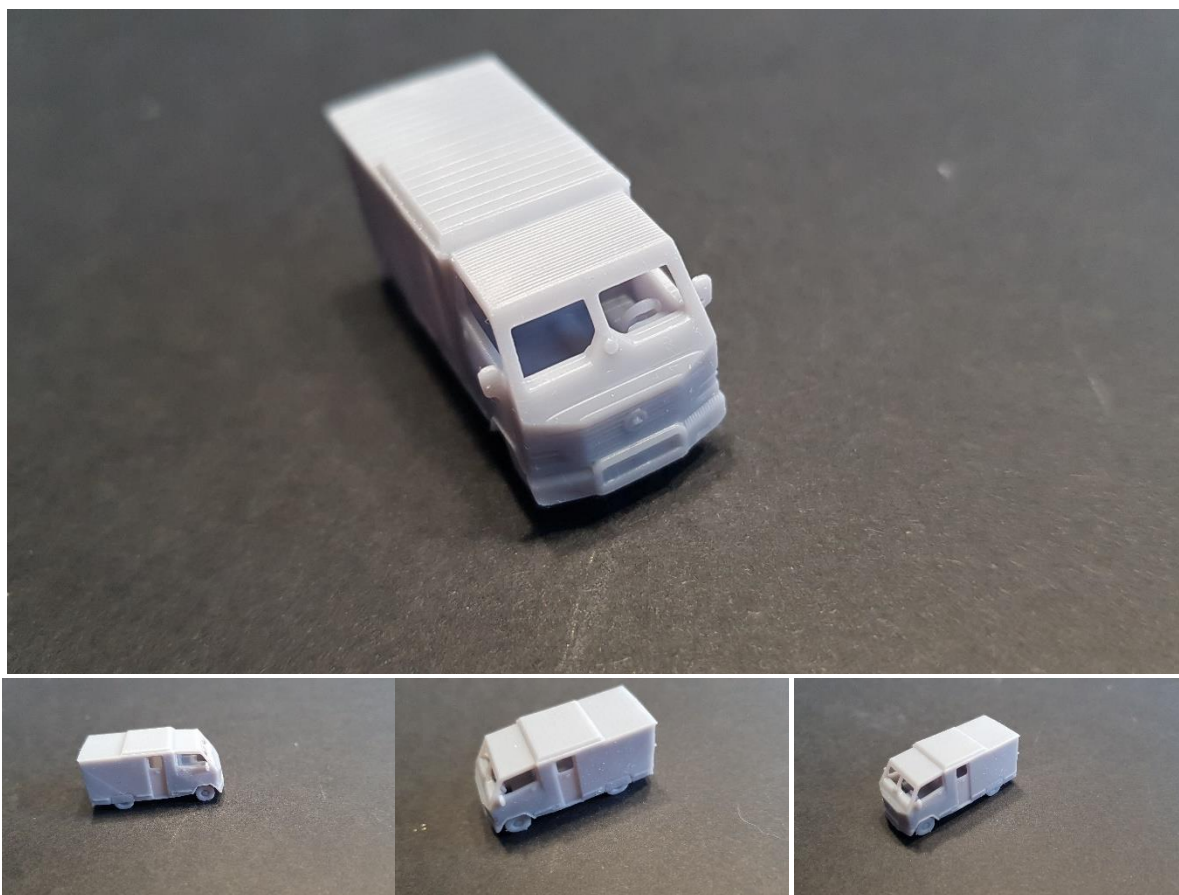

Camion blindé _____ 7€

S.P.A.N

12 rue Alain-fourmier

53000 Laval

0619443310 - stpoup1@gmail.com

N°Siret : 891 865 883 00013



Camion grue GRIFFET

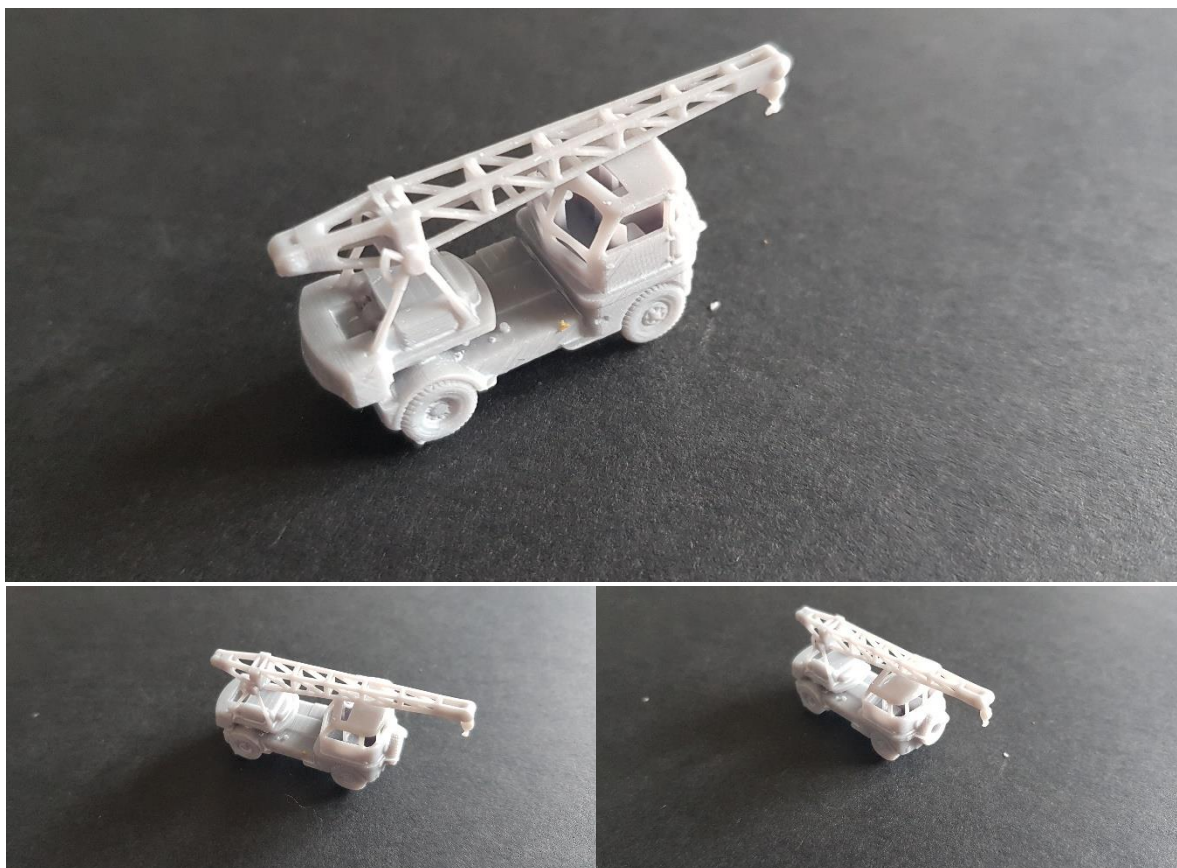

Camion grue _____ 10€

S.P.A.O.

12 rue Alain-fourrier

53000 Laval

0619443310 - stpoup1@gmail.com

N°Siret : 891 865 883 00013



Bus SAVIEM SC10 (3 modèles)

Type 044, Type 244, Type 444

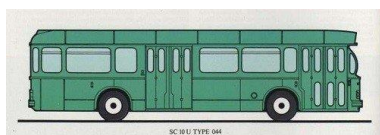

Type 044

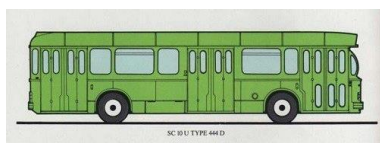

Type 444

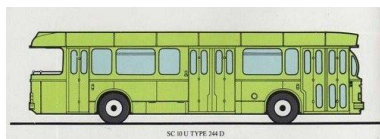

Type 244

Le bus _____ 8€

(Le lot de 3 = 20€) – Possibilité de panacher.

S.P.A.N

12 rue Alain-fournier

53000 Laval

0619443310 - stpoup1@gmail.com

N°Siret : 891 865 883 00013



TACOTS – lot de 6 (panachage possible) _____ 30€



Tatra 11 (2 modèles)



Vauxhall D25 (2 modèles)



Ford Tudor 1929

S.P.A.N

12 rue Alain-fournier

53000 Laval

0619443310 - stpoup1@gmail.com

N°Siret : 891 865 883 00013



VEHICULES MILITAIRES



Le VAB (8€) – la Jeep (2€)

S.P.A.O.

12 rue Alain-fournier

53000 Laval

0619443310 - stpoup1@gmail.com

N°Siret : 891 865 883 00013



Péniches (péniche pleine à poser ou péniche vide à encastrer) _____ 50€



Le chalutier _____ 25€

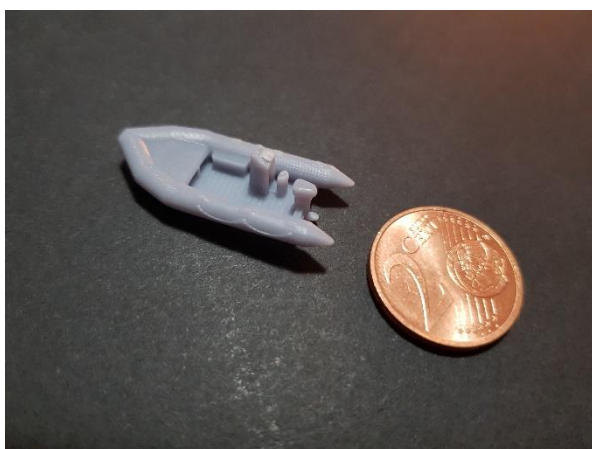

Le zodiac (3€ avec le chalutier) _____ 5€

S.P.A.N

12 rue Alain-fournier

53000 Laval

0619443310 - stpoup1@gmail.com

N°Siret : 891 865 883 00013



Modélisme au 160^{ème} en impression 3D



ACHAT

Pour toute commande, merci de m'adresser un mail ou en complétant le formulaire. En précisant les modèles et quantités souhaités.

La demande du règlement vous sera envoyé sur votre mail de contact une fois les pièces imprimées – Le règlement se fera ensuite par chèque ou virement bancaire.

A réception du règlement, votre commande vous sera envoyée accompagnée de la facture.

Cordialement

Intitulé du compte		M POUPIN STEPHANE 1 RUE DES ARDENNES 91940 LES ULIS	
Domiciliation			
Code banque	Code guichet	Numéro de compte	Clé RIB
14706	00181	40039102001	56
IBAN		FR76 1470 6001 8140 0391 0200 156	
Code BIC (Bank identification code) - code SWIFT		AGRIFRPP847	

S.P.A.N

12 rue Alain-fourmier

53000 Laval

0619443310 - stpoup1@gmail.com

N°Siret : 891 865 883 00013